



2023 ENGLISH

TABLE OF CONTENTS

RIFlescOPES AND SIGHTS

TECHNOLOGY	3-6
VX-6HD	9
VX-5HD	12
NEW VX-3HD	13
VX-FREEDOM	14
FREEDOM RDS	15
COMPETITION	16
FX	17
HANDGUN	18
PATROL 6HD	20
MARK 5HD	21
MARK 3HD	22
DELTAPOINT PRO	23
DELTAPOINT MICRO	24

BINOCULARS

BX-5 SANTIAM HD	27
BX-4 PRO GUIDE HD	28
NEW BX-4 RANGE HD TBR/W	29
BX-2 ALPINE HD	31
NEW BX-1 MCKENZIE HD	32
BX-1 ROGUE COMPACT	32

SPOTTING SCOPES

GOLD RING	35-37
MARK 4 TACTICAL	36
SX-5 SANTIAM HD	39
SX-4 PRO GUIDE HD	40
SX-2 ALPINE HD	41

RANGEFINDERS

TECHNOLOGY	44
RX-2800 TBR/W	45
RX-1600i TBR/W	46
RX-1500i TBR/W	47
RX-1400i TBR/W	47
RX-FULLDRAW 5	48

NEW PERFORMANCE EYEWEAR

NEW LEUPOLD PRO GEAR

MOUNTS

SPECIFICATIONS

RIFlescOPES	63-65
BINOCULARS/SPOTTING SCOPES	67
RANGEFINDERS	68

RETICLES

RETICLE OPTIONS	69-77
RETICLE SUBTENSIONS	79-80
RETICLES BY MODEL	81

PRODUCT SERVICE INFORMATION

82





TRUST IS EARNED

Gear that doesn't work doesn't belong in your pack. That's why every product we make is guaranteed to operate at the highest level. Whether you're going after your target buck or the top spot on the podium, you know our optics will never let you down. That level of trust is earned. It's won by dominating thousands of hard hunts, winning countless adrenaline-filled matches, and protecting our country for decades on the battlefield. No matter what happens to you when the pressure's on, our designs will survive every epic moment and deliver the premium clarity they're known for, just as they have for the past 100 years.

So go ahead, Be Relentless.

A handwritten signature in black ink, appearing to read 'Bruce Pettet', written in a cursive style.

Bruce Pettet
President & CEO
Leupold & Stevens, Inc.

LEUPOLD GOLD RING GUARANTEE.

WE GUARANTEE PERFORMANCE, OTHERS WARRANTY FAILURE.

If your Leupold product doesn't perform as promised, we will repair or replace it for free, whether you are the original owner or not - forever (excludes electronic components). For competitive reasons some European countries limit the guarantee to 30 years. After that period you can rely on Leupold's generous customer service - no ifs, ands, or buts!

We can do this because we use superior craftsmanship to create superior optics, and we're confident your Leupold won't let you down at a crucial moment. That's the power of our company: we stand behind our work.

Please contact your LEUPOLD dealer.

RELENTLESS INNOVATION

Leupold invented most of the riflescope technology you might take for granted—from the ubiquitous Duplex® reticle to nitrogen-filled, waterproof and fogproof optics. Today, we're developing new technologies that give you the best chance possible for first-shot success.

ADVANCED OPTICAL SYSTEM

Leupold's Advanced Optical System offers tried-and-true light transmission for extended glassing sessions, best in class glare reduction in harsh light, and the resolution and clarity that recreational sportsmen and sportswomen demand.

ELITE OPTICAL SYSTEM

Leupold's Elite Optical System offers excellent dawn-to-dusk light transmission for a bright image when it matters most, elite-level glare reduction in harsh light, and the resolution and clarity that diehard hunters and shooters demand.

PROFESSIONAL-GRADE OPTICAL SYSTEM

Leupold's Professional-Grade Optical System offers unmatched light transmission that's designed to outperform in the most challenging lighting conditions, industry-leading glare reduction for a clear image in harsh, direct light, and the resolution and clarity that professional guides and shooters demand in the field.

GUARD-ION HYDROPHOBIC LENS COATING

Our proprietary lens coating sheds water, dirt, oils, and more keeping your lenses clean and clear.

SCRATCH RESISTANT LENSES

Provides added lens durability that far exceeds industry standards.

CUSTOM DIAL SYSTEM® (CDS®)

CDS simplifies longer shots by eliminating the need for holdovers or ballistic calculations, using a custom dial that's specific to your rifle and ammo.

MOTION SENSOR TECHNOLOGY (MST™)

Always be ready to go with motion activated reticle illumination. It extends battery life by shutting off illuminated reticles after five minutes of inactivity and instantly turns on when moved.

TRUE BALLISTIC RANGE/WIND (TBR/W)

Leupold RX rangefinders with TBR/W technology take into account the distance, angle of your shot, and your rifle's ballistics to calculate an accurate shoot distance out to 732 meters. Other rangefinders can't give you an accurate range to your target because they use basic trigonometry to calculate a straight-line horizontal distance (rifleman's rule). Additionally, TBR/W provides a 10-mph full wind hold value (90° angle) to enable you to make quick adjustments on the fly. When combined with a Leupold CDS scope with windplex, TBR/W provides an extremely fast and accurate solution to get you on target at any distance and wind condition.

TROPHY SCALE™

Take the guesswork out of measuring the width or height of an animal's rack with our proprietary Trophy Scale software found in select RX Rangefinder models.

ARCHER'S ADVANTAGE™ SOFTWARE

Select Leupold RX rangefinders now offer custom ballistic solutions using Archer's Advantage™ software. Using your arrow weight, arrow velocity, and peep height, Archer's Advantage™ software calculates extremely accurate ballistic solutions for high-angle short-distance shots, and medium-angle long-distance shots.

FLIGHTPATH™ TECHNOLOGY

Leupold RX rangefinders with Flightpath technology make it easy to determine if your arrow will clear obstructions between you and the target out to a typical distance of 78 meters. An illuminated mark in the display indicates the highest point of your arrow's trajectory so you can take tight shots with total confidence.



LEUPOLD OPTICAL SYSTEMS

DELIVERING INDUSTRY-LEADING BRIGHTNESS AND CLARITY

Each Leupold Optical System builds off of the previous one to ensure every Leupold product has the clearest, brightest image in its class.

The Advanced Optical System has stood the test of time and outperforms most optics on the market, while the Elite Optical System delivers even more performance for those diehard hardcore hunters and shooters who demand as much from their optics as they do from themselves. The Professional-Grade Optical System delivers unmatched performance for professional guides and shooters who require the brightest, clearest optics on the market, no matter the conditions.

WHICH OPTICAL SYSTEM IS RIGHT FOR YOU?

ADVANCED OPTICAL SYSTEM

Leupold's Advanced Optical System offers tried and true light transmission for extended glassing sessions, best in class glare reduction in harsh light, and the resolution and clarity that recreational sportsmen and sportswomen demand.

ELITE OPTICAL SYSTEM

Leupold's Elite Optical System offers excellent dawn-to-dusk light transmission for a bright image when it matters most, elite-level glare reduction in harsh light, and the resolution and clarity that diehard hunters and shooters demand.

PROFESSIONAL-GRADE OPTICAL SYSTEM

Leupold's Professional-Grade Optical System offers unmatched light transmission that's designed to outperform in the most challenging lighting conditions, industry-leading glare reduction for a clear image in harsh, direct light, and the resolution and clarity that professional guides and shooters demand in the field.



FIRST-SHOT ACCURACY: LEUPOLD'S CUSTOM DIAL SYSTEM

The Custom Dial System (CDS) makes accurate long-range shooting this simple: range your target, turn your CDS dial to match the range, aim dead on, then squeeze the trigger. With a CDS dial and some practice, you can shoot farther and more accurately than ever before.

Here's how it works: we customize your scope's elevation dial to match your exact load, velocity, and even the average atmospheric conditions where you hunt for unprecedented precision. With your CDS dial, you'll easily compensate for bullet drop and make ultra-quick adjustments on the fly.

You can even create multiple dials for the same rifle scope to match different loads or different conditions. Best of all, **YOUR FIRST CDS DIAL IS FREE** when you purchase any CDS-ready rifle scope.

OTHER CDS FEATURES INCLUDE:

- Instantly return to zero with the zero-stop
- Easily change dials for different loads; simply loosen the set screws and swap out the dials
- Precision click adjustments for accurate zeroing
- Permanently laser-engraved load information and range markings
- CDS-TZL2 and CDS-TZL3 target models available with micrometer style, multi-turn adjustments
- With CDS-ZeroLock® 2 (CDS-ZL2) dials, you get two revolutions of elevation, quickly set your dial or return to zero with the push of a button, and eliminate accidental dial rotation



CDS is available on all VX-6HD, VX-3HD and select VX-5HD and VX-Freedom models.



350 METERS

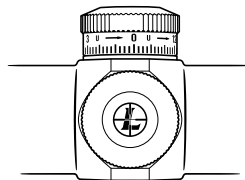

550 METERS

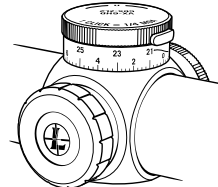

CDS AND LEUPOLD RANGEFINDERS

Put these systems together and you've got a long-range shooting machine on your hands. RX rangefinders use Leupold's exclusive True Ballistic Range to give you the most accurate ballistic range to your target. The Custom Dial System is an elevation dial created specifically for your rifle, matched to its ballistics. Once you have the range with your Leupold rangefinder, turn your CDS dial to the correct number (i.e. 5.5 for 550 meters), aim dead on, and squeeze the trigger.



LEUPOLD DIAL GUIDE



MICRO-FRICTION ADJUSTMENTS
Marked in easy-to-read increments. Low-profile, covered dials. Set it and forget it.



COIN CLICK ADJUSTMENTS
Easily adjusted with a coin, turret cap, or tool. Low-profile, covered dials. Fast, precise sight-in. Reset ring and index mark makes returning to zero simple.



FINGER CLICK ADJUSTMENTS WITH RESETTABLE ZERO INDICATOR
Low-profile covered dials. Fast, precise sight-in without coins or tools.



POP UP REZERO DIAL
Easily align the zero on the dial to the index mark on the housing by popping up, spinning, and snapping down the dial.



ZEROLOCK WINDAGE DIALS
Prevents unintended adjustments and ensures an accurate return to zero. Fast and easy to use.



CDS DIALS
Low-profile, 1/4-MOA click adjustments. Can be laser engraved with your custom load information and range markings. No cover to lose. Your first CDS dial is engraved for free, when you purchase any CDS-ready rifle scope.



CDS ZEROLOCK DIAL
Low-profile, one revolution, CDS-ready dials. Push the lock release button to unlock it and dial, then simply rotate it back to zero to lock it back in place. Can be laser engraved with your custom load information.



CDS-ZL2 DIALS
Low-profile, two revolution, CDS-ready dials. The lock release button protrudes on the first revolution and is flush on the second. Can be laser engraved with your load information and range markings.



CDS-TZL3 DIALS
Large, three revolution dial designed for precision adjustments. CDS-TZL3 dial features a re-settable ZeroLock and an easy-to-read rotation indicator so you know how far you've dialed.



CDS-T ZEROLOCK DIALS
Large dial provides access to the entire adjustment range of your scope. CDS-T comes capped and features an easy-to-read rotation indicator. Can be laser engraved with your custom load information.



P5 DIALS
Low-profile, exposed dials with tactile, audible clicks providing precise 0.1 MIL elevation and windage adjustments.



M5C3 ZEROLOCK DIALS
Low-profile, three revolution dials. 1/10-MIL per click for 30-MILs of adjustment in 3 turns, at 10-MILs per turn. The ZeroLock feature prevents inadvertent adjustments and ensures accurate return to zero.



M1C3 ZEROLOCK DIALS
Low-profile, three revolution dials. 1/4-MOA per click for 75-MOA of adjustment in 3 turns, at 25-MOAs per turn. The ZeroLock feature prevents inadvertent adjustments and ensures accurate return to zero.

HUNTING DIALS							
Adjustment Type	Click Increment	Adjustment Per Revolution	Lock Type	Travel Limit	Rezero Type	2 Revolution Indicator	Custom Ballistic Lasering [CDS]
Finger Click	1/4-MOA	15 MOA	None	Scope Total Travel	Index Ring	None	No
Finger Click (Metric)	1 cm / 100 m (0.1-MIL)	60 cm / 100 m (6-MIL)	None	Scope Total Travel	Index Ring	None	No
CDS	1/4-MOA	15 MOA, 60 cm	None	Scope Total Travel, or 14-MOA with Zero Stop Custom Dial	Dial Slip	None	Yes
CDS-ZL	1/4-MOA	20 MOA	ZeroLock	18 MOA	Rear Facing Index Mark, Set Screw	None	Yes
CDS-ZL2	1/4-MOA	20 MOA	ZeroLock	38 MOA	Rear Facing Index Mark, Set Screw	Sinking Button	Yes
CDS-ZL2 (Metric)	1 cm / 100 m (0.1-MIL)	80 cm / 100 m (8-MIL)	ZeroLock	152 cm / 100 m (15.2-MIL)	Rear Facing Index Mark, Set Screw	Sinking Button	Yes
CDS-T	1/4-MOA	15 MOA	None	Scope Total Travel	Dial Slip	None	Yes
CDS Target (VX-6 7-42x56)	1/8-MOA	20-MOA	None	Scope Total Travel	Rear Facing Index Mark, Set Screw	Rotation Indicating Hashmarks	Yes
CDS-TZL3	1/4-MOA	20 MOA	Push Button	58 MOA	Rear Facing Index Mark, Set Screw	Yes	Yes

TACTICAL DIALS					
MODEL	Elevation Adjustment Style	Elevation	Windage	Zero Stop/Revolutions	Travel/Revolution
Mark 3HD	P5	1/10-MIL	1/10-MIL	Yes	6 MIL
Mark 5HD (5-25x)	M1C3/M5C3 ZeroLock	1/10-MIL, 1/4-MOA	1/10-MIL, 1/4-MOA	Yes/3*	10.5-MIL 25 MOA
Mark 5HD (3.6-18x)	M1C3/M5C3 ZeroLock	1/10-MIL, 1/4-MOA	1/10-MIL, 1/4-MOA	Yes/3*	10.5-MIL 25 MOA
Mark 5HD (7-35)	M1C3/M5C3 ZeroLock	1/10-MIL, 1/4-MOA	1/10-MIL, 1/4-MOA	Yes/3*	10.5-MIL 25 MOA
Patrol 6HD	CDS-ZL2/Pop Up Rezero	1/4-MOA	1/4-MOA	Yes/2	20 MOA

*30-MILs total with Tactile Revolution Indicator





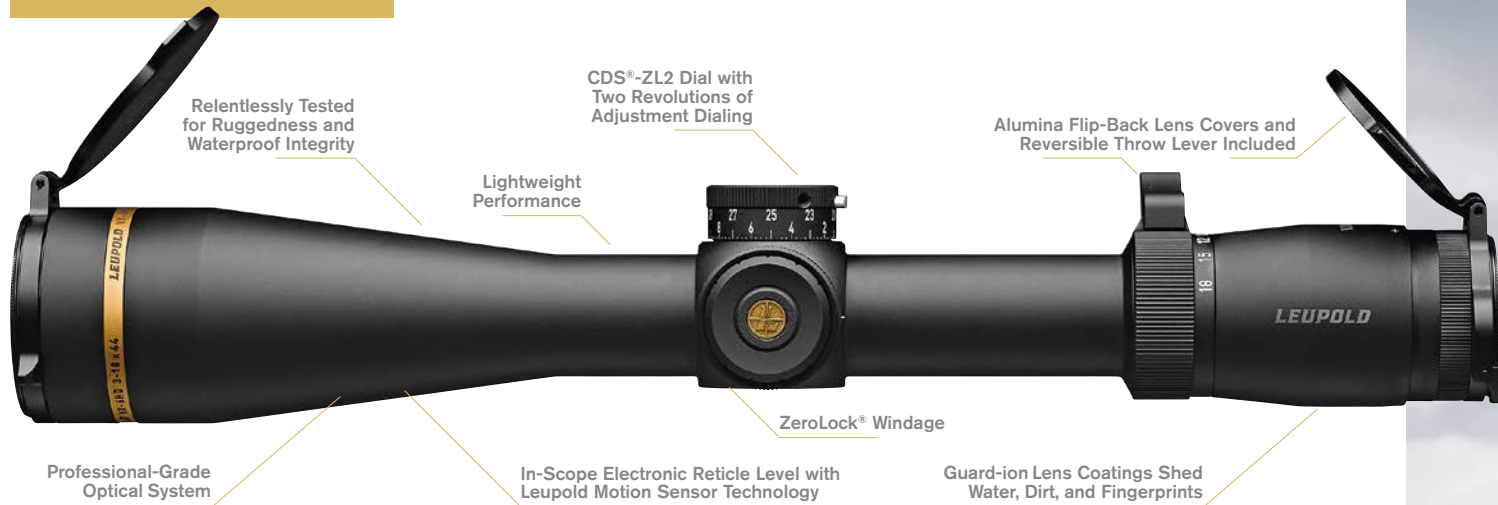

VX-6HD



Any hunt, anywhere, anytime, your VX®-6HD is ready for anything. Put it to your eye, and you'll see the difference. In any light and any conditions, its edge-to-edge brightness, clarity, and resolution give you the edge you need when it counts. The 6:1 zoom and the latest technology, including an in-scope electronic reticle level, make your VX-6HD the most versatile Leupold® riflescope ever made. If first-shot success matters to you, you won't do better than a VX-6HD.

VX-6HD Illuminated Reticle	RETICLE	Model #	Obj.	Maintube	Weight (grams)	Length (cm)	Eye Relief (mm)	FOV (m @ 100 m)	Elev. Adj. MOA
1-6x24 CDS-ZL2	A	171552	24mm	30mm	380	27,3	94 - 97	40,30 - 6,40	170
2-12x42 CDS-ZL2	A	171563	42mm	30mm	564	31,9	94 - 97	18,83 - 3,20	120
3-18x44 Side Focus CDS-ZL2	A	171565	44mm	30mm	612	34,4	94 - 97	12,77 - 2,13	75
	B	171568							
3-18x50 Side Focus CDS-ZL2	A	171572	50mm	30mm	649	34,4	94 - 97	12,77 - 2,13	75
	B	171576							
	C	175835*							
4-24x52 CDS-ZL2	D	171581	52mm	34mm	720	37,3	94 - 97	9,37 - 1,60	75
	A	179294							
	B	171579							
4-24x52 Side Focus CDS-TZL3	B	179292	52mm	34mm	723	37,3	94 - 97	9,37 - 1,60	75

All models are Second Focal Plane (SFP). For more information, See page 69.

* Throw lever and lens covers not included. Metric adjustments.

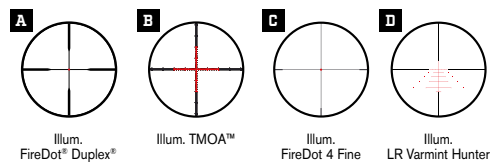

For more information and to see enlarged reticles, see pages 69-81.



All VX-6HD scopes are equipped with an Electronic Reticle Level.

When it's switched on, the illuminated reticle will blink if the VX-6HD is tilted more than one degree left or right. Bring it level, and the reticle will remain solid. This feature can aid in mounting the scope or using holdovers at long distances.

The leveling function can be switched on or off to suit your preference.







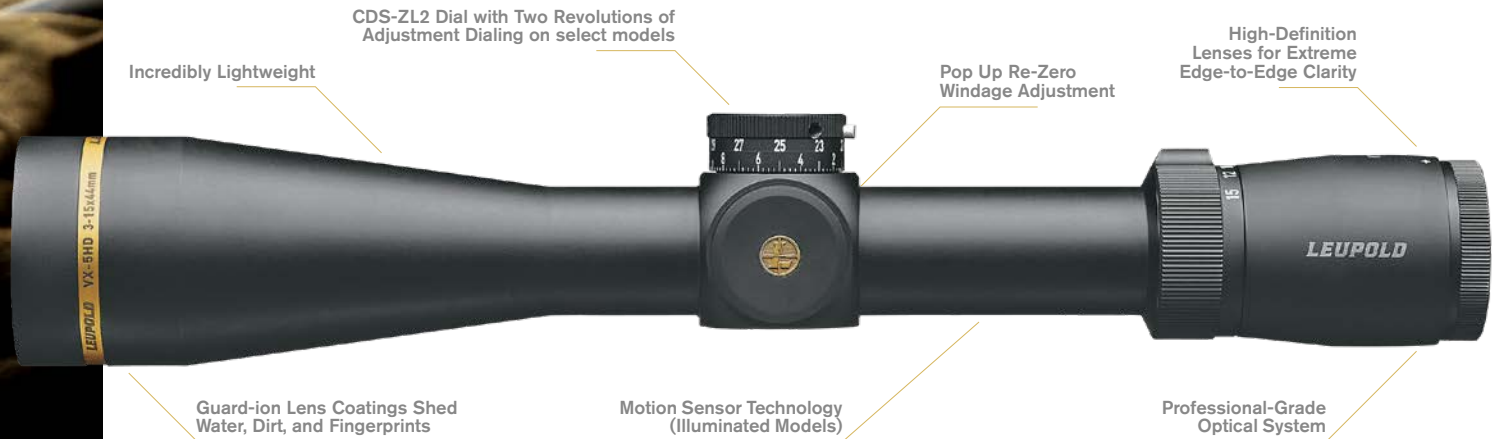

VX-5HD



There are places where you can only take the essentials; the VX®-5HD has everything you need and nothing you don't. With high-definition lenses and extended low-light hunting performance, you can make the most of every second. When it's time to pull the trigger, you'll want the accuracy and additional elevation the two-turn CDS® ZeroLock® 2 dials deliver. As the lightest, most rugged 5:1 rifle scope in its class, your VX-5HD will never slow you down.

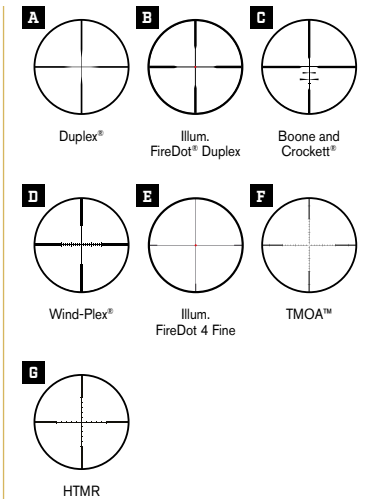

For more information and to see full-size reticles, see pages 69-81.

VX-5HD	RETICLE	Model #	Obj.	Maintube	Weight (grams)	Length (cm)	Eye Relief (mm)	FOV (m @ 100 m)	Elev. Adj. MOA
1-5x24 Metric	E	171385	24mm	30mm	388	27,3	94 - 97	40,30-13,43	170
1-5x24 CDS-ZL2	B	172367	24mm	30mm	417	27,3	94 - 97	40,30-13,43	170
2-10x42	A	171386	42mm	30mm	507	31,9	94 - 97	18,83-3,83	120
2-10x42 CDS-ZL2	B	171389	42mm	30mm	536	31,9	94 - 97	18,83-3,83	120
3-15x44 Side Focus CDS-ZL2	A	171714	44mm	30mm	558	34,4	94 - 97	12,77 - 2,57	75
	B	172368							
	C	171717							
	D	171715							
	B	178027							
3-15x56 Side Focus CDS-ZL2	B	171390	56mm	30mm	629	34,5	94 - 97	12,77 - 2,57	75
3-15x56 Side Focus CDS-ZL2 Metric	E	175834	56mm	30mm	629	34,5	94 - 97	12,77 - 2,57	75
4-20x52 Side Focus CDS-ZL2	A	171701	52mm	34mm	658	37,3	94 - 97	9,37-1,93	110
	B	178166							
4-20x52 Side Focus CDS-TZL3	F	171700	52mm	34mm	675	37,3	94 - 97	9,37-1,93	110
7-35x56 Side Focus CDS-TZL3	E	172754	56mm	34mm	728	39,6	94 - 97	5,43-1,03	55

All models are Second Focal Plane (SFP). For more information, See page 69.

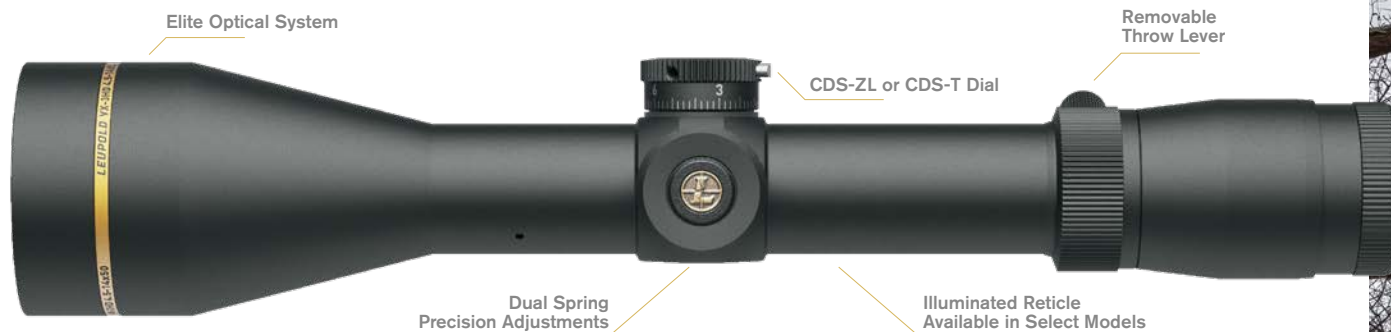

VX-3HD



The VX®-3HD delivers what hunters want most in a riflescope: outstanding performance in low light, in an incredibly tough yet lightweight package. With Leupold's Elite Optical System, the VX-3 HD delivers excellent dawn-to-dusk light transmission for a bright image when it matters most, elite-level glare reduction in harsh light, and the resolution and clarity that diehard hunters and shooters demand. We also gave it match-grade repeatability and ergonomic controls that are easy to read and use, even with gloves. Models with illuminated reticles make the VX-3HD the best lightweight, low-light hunting scope in its class. And with its low-profile, one revolution CDS® ZeroLock® dial, you can be confident your dial will only move when you want it to. Push the button to unlock it, dial, and then rotate it back to zero to lock it in place. It's that simple. Everything we put into your VX-3HD is there to help you tag out.



VX-3HD	RETICLE	Model #	Obj.	Maintube	Weight (grams)	Length (cm)	Eye Relief (mm)	FOV (m @ 100 m)	Elev. Adj. MOA		
1.5-5x20 CDS-ZL	A	180615	20mm	1 inch	274	24.7	112 - 92	22,53 - 8,03	125		
1.5-5x20 CDS-ZL	B	180626	20mm	30mm	354	24.7	112 - 92	22,53 - 8,03	125		
2.5-8x36 CDS-ZL	A	180616	36mm	1 inch	334	29.0	112 - 92	12,50 - 4,57	70		
3.5-10x40 CDS-ZL	A	180617	40mm	1 inch	382	32.2	112 - 92	9,67 - 3,67	55		
3.5-10x40 CDS-ZL	B	180627	40mm	30mm	447	32.2	112 - 92	9,67 - 3,67	55		
3.5-10x50 CDS-ZL	A	180618	50mm	1 inch	428	31.2	112 - 92	9,90 - 3,67	55		
3.5-10x50 CDS-ZL	B	180628	50mm	30mm	498	31.2	112 - 92	9,90 - 3,67	95		
4.5-14x40 CDS-ZL	A	180619	D	180620	40mm	1 inch	379	32.2	112 - 92	6,63 - 2,47	75
4.5-14x40 CDS-ZL Burnt Bronze	C	180621	40mm	1 inch	379	32.2	112 - 92	6,63 - 2,47	75		
4.5-14x40 Side Focus CDS-ZL	C	180623	40mm	30mm	453	31.2	112 - 92	6,63 - 2,47	75		
4.5-14x50 CDS-ZL	A	180622	50mm	1 inch	479	31.2	112 - 92	6,83 - 2,53	75		
4.5-14x50 Side Focus CDS-ZL	B	180629	50mm	30mm	549	31.2	112 - 92	6,83 - 2,53	75		
4.5-14x40 Side Focus CDS-T	F	182567	40mm	30mm	453	31.8	112 - 92	6,83 - 2,53	75		
6.5-20x40 EFR CDS-T	E	182502	F	182666	40mm	1 inch	516	36,8	112 - 92	4,36 - 1,68	45
6.5-20x50 EFR Side Focus CDS-T	E	182900	F	182568	50mm	30mm	589	36,5	112 - 92	4,29 - 1,77	65

Gold = New Products

All models are Second Focal Plane (SFP). For more information, See page 69.

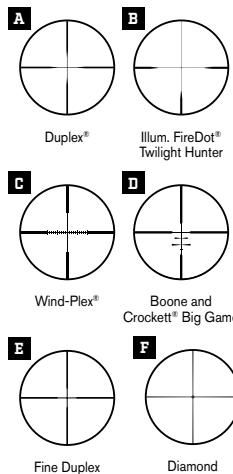

For more information and to see full-size reticles, see pages 69-81.



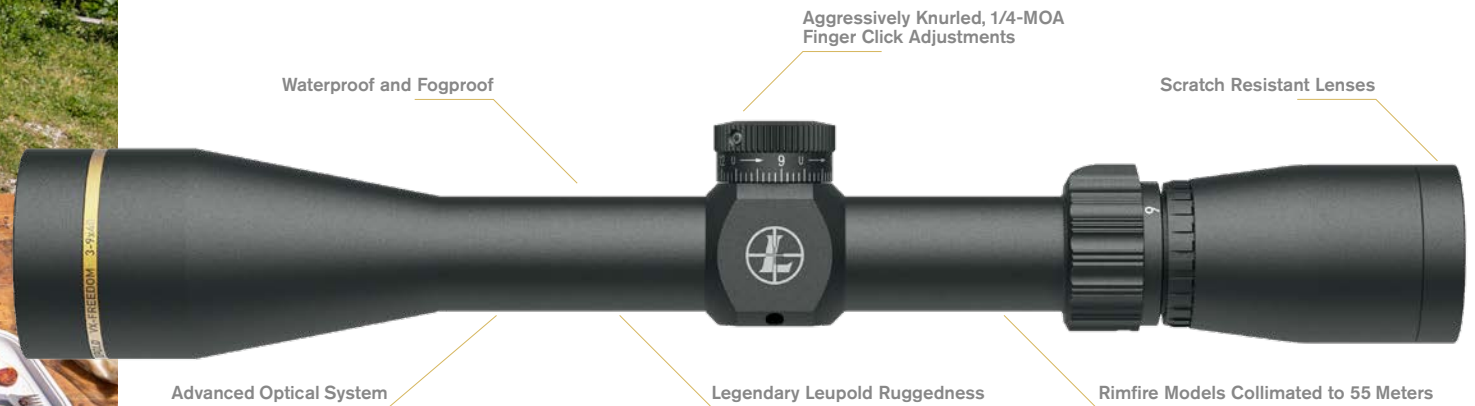

VX-FREEDOM®



The VX®-Freedom® delivers the legendary Leupold® performance and dependability hunters and shooters have demanded for decades. With the VX-Freedom you get best-in-class optics, unbeatable accuracy, and a wide variety of reticles. It's also everything you expect from a Leupold: designed, machined, and assembled in our Oregon factory, tested to the same ruggedness standards as our top-tier riflescopes, and covered by the Leupold 30-year guarantee.

VX-Freedom	RETICLE	Model #	Obj.	Maintube	Weight (grams)	Length (cm)	Eye Relief (mm)	FOV (m @ 100 m)	Elev. Adj. MOA		
1.5-4x20	I	180590	J	174177	20mm	1 inch	272	23,9	106-95	24,73 - 9,80	125
1.5-4x28 IER Scout	A	175074			28mm	1 inch	272	28,2	176-154	13,90 - 5,77	67
2-7x33	C	180592			33mm	1 inch	315	28,0	106-94	14,60 - 9,93	75
2-7x33 Rimfire	D	174179			33mm	1 inch	315	28,0	106-94	14,60 - 9,93	75
3-9x33 EFR Airgun	H	175075			33mm	1 inch	343	29,0	106-93	11,03 - 4,53	64
3-9x40	C	181307			40mm	1 inch	346	31,5	106-93	11,03 - 4,53	60
3-9x40 CDS	A	174182	B	180603	40mm	1 inch	346	31,5	106-93	11,03 - 4,53	60
3-9x40 Rimfire	D	174181			40mm	1 inch	346	31,5	106-93	11,03 - 4,53	60
3-9x40 450 Bushmaster	A	176011			40mm	1 inch	346	31,5	106-93	11,03 - 4,53	60
3-9x40 350 Legend	A	177910			40mm	1 inch	346	31,5	106-93	11,03 - 4,53	60
3-9x40 Muzzleloader	F	174184			40mm	1 inch	346	31,5	106-93	11,03 - 4,53	60
3-9x50 CDS	A	180613	C	181787	50mm	1 inch	414	30,7	106-93	11,03 - 4,53	60
3-9x50	E	177228			50mm	30mm	483	30,7	130-96	11,03 - 4,53	60
4-12x40 CDS	A	180600	B	180601	40mm	1 inch	371	31,5	106-95	7,17 - 3,33	80
4-12x40 CDS Side Focus	B	175079			40mm	30mm	457	31,5	133-96	6,83 - 3,73	76
4-12x40 Creedmoor	G	179313			40mm	1 inch	371	31,7	106-95	7,17 - 3,33	80
4-12x50 CDS	A	180602			50mm	1 inch	425	30,7	106-93	7,33 - 3,50	56
6-18x40 CDS Side Focus	B	175081			40mm	30mm	482	37,1	130-96	4,37 - 2,27	56

All models are Second Focal Plane (SFP). For more information, See page 69.

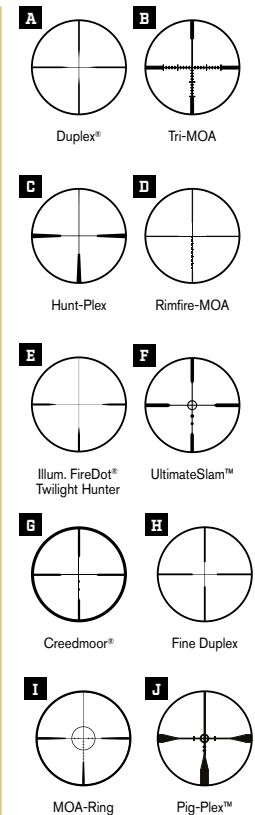

For more information and to see full-size reticles, see pages 69-81.



FREEDOM RDS®



All red dots are not created equal. The Freedom RDS® (red dot sight) changes the game when it comes to consistency and durability in a red dot sight. We took our 70+ years of optics knowledge and created a red dot that's built Leupold® tough, performs in extreme conditions, and won't break the bank. It's everything you need in a red dot and nothing you don't.

FREEDOM RDS Red Dot Sight	RETICLE	Model #	Weight (g)	Length (mm)	Elev. Adj. MOA
1x34 RDS w/Mount	A	180092	195,6	134,62	80
1x34 RDS 223 BDC w/Mount	A	180093 - BDC	195,6	134,62	80
1x34 RDS w/o Mount	A	180091	195,6	134,62	80



Installs Easily With AR-height Mount

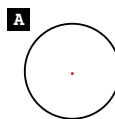

1 MOA Dot

8 brightness settings ranging from night-vision compatibility to full-daylight visibility



Available With Pre-calibrated .223 Rem BDC Dial



@ dreispross



COMPETITION

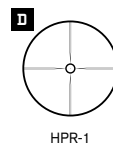
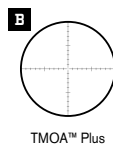
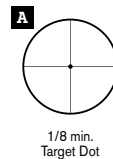
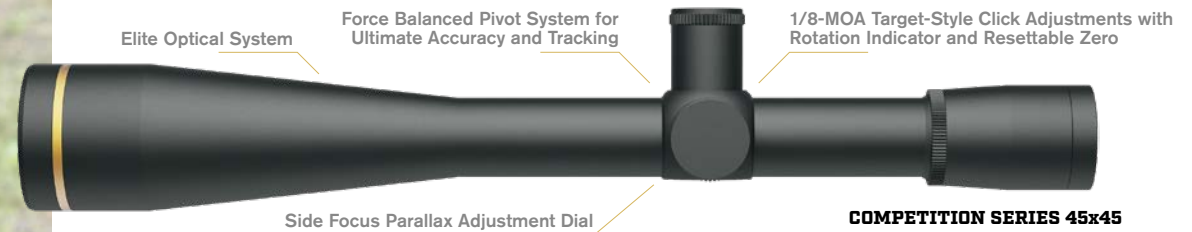

For more information and to see full-size reticles, see pages 69-81.



Competition	RETICLE	Model #	Obj.	Maintube	Weight (grams)	Length (cm)	Eye Relief (mm)	FOV (m @ 100 m)	Elev. Adj. MOA
Competition Series 45x45	A	53440	45mm	30mm	576	40,4	81	0,80	40
VX-6 7-42x56 Side Focus CDS Target	B	118504	56mm	34mm	745	39,4	107 - 98	5,40 - 0,90	65
VX-4.5HD Service Rifle 1-4.5x24 CDS-ZL2	C	176281	24mm	30mm	351	27,4	94 - 97	41,07 - 8,70	170
FX-4.5HD Service Rifle 4.5x24 CDS-ZL2	D	176284	24mm	30mm	375	26,7	80	8,70	130

All models are Second Focal Plane (SFP). For more information, See page 69.





There's no secret to the enduring popularity of Leupold's fixed power riflescopes. Their simplicity, rugged performance, and supreme accuracy speak volumes. We put our 70+ years of optical know-how into each one, for brightness, contrast, and resolution that has to be seen to be appreciated.

FX	RETICLE	Model #	Obj.	Maintube	Weight (grams)	Length (cm)	Eye Relief (mm)	FOV (m @ 100 m)	Elev. Adj. MOA
FX-II 2.5x20 Ultralight	A	58450	20mm	1 inch	184	20,3	124	13,20	147
FX-I 4x28 Rimfire	B	58680	28mm	1 inch	213	23,4	114	8,50	95
FX-3 6x42	A	66815	42mm	1 inch	386	33,5	113	5,80	70

All models are Second Focal Plane (SFP). For more information, See page 69.

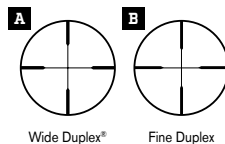

Wide Duplex®

Fine Duplex

For more information and to see full-size reticles, see pages 69-81.

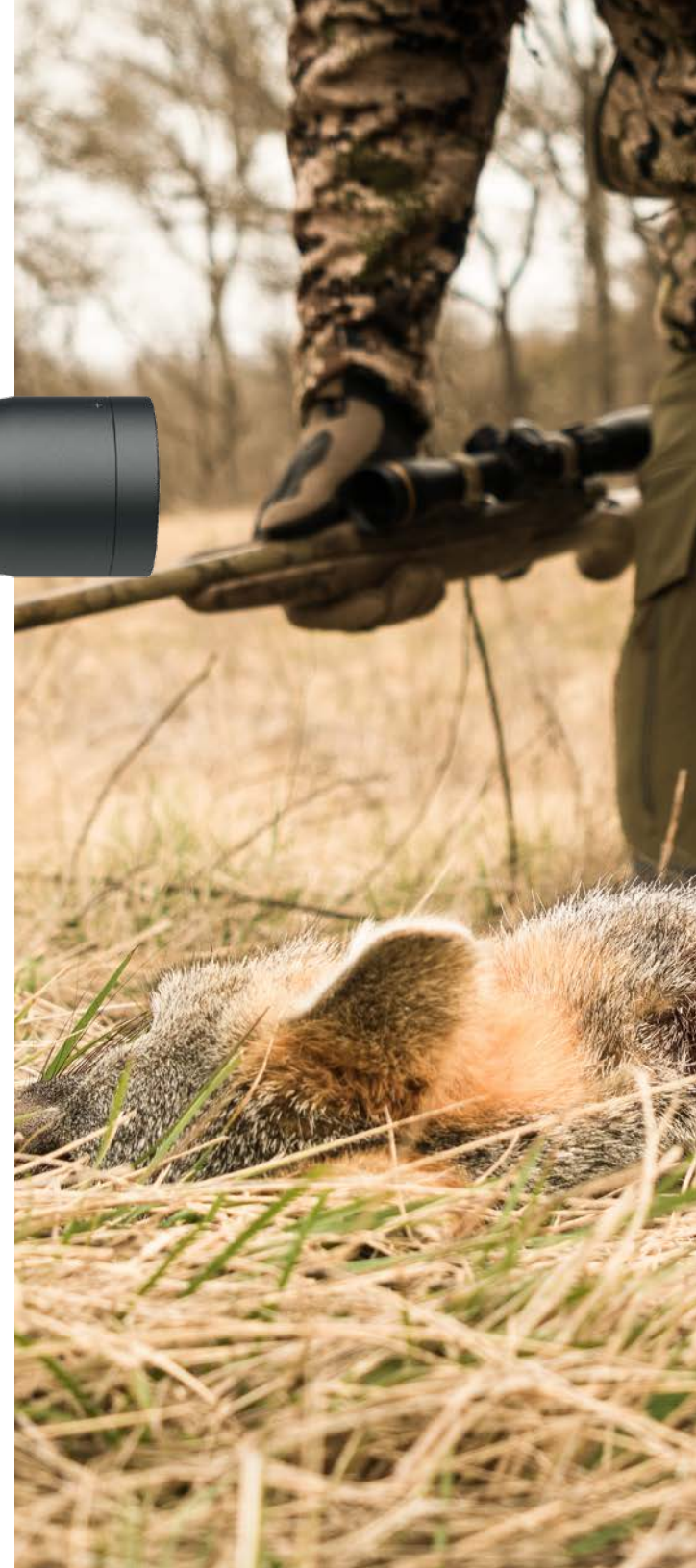



HANDGUN



Leupold® handgun scopes not only eliminate the need to focus on the front sight, they totally eliminate the inaccuracy of a handgun's short sight radius. All that's left is you, the crosshairs, and the target. These scopes can take a beating, too. They're specially designed to handle the crushing recoil of the latest hunting handguns and tested to the same harsh standards as all Leupold scopes.

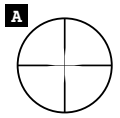

Duplex®

For more information and to see full-size reticles, see pages 69-81.

Handgun	RETICLE	Model #	Obj.	Maintube	Weight (grams)	Length (cm)	Eye Relief (mm)	FOV (m @ 100 m)	Elev. Adj. MOA
FX-II 4x28	A	58750	28mm	1 inch	199	21,3	457	3,00	110
VX-3 2.5-8x32	A	67825	32mm	1 inch	309	29,0	381 - 381	4,30 - 1,60	110

All models are Second Focal Plane (SFP). For more information, See page 69.





PATROL 6HD™



With the Patrol 6HD, you can defend your ground without worry. Its ultra-lightweight, low-profile design deploys quickly, while its 1-6 magnification range lets you engage threats anywhere from tight corners to open fields. Whether your mission is to protect and serve or you're looking for an edge in competitive Dynamic Rifle Shooting Disciplines, this battle-ready scope will help you accurately ID targets within seconds. It's waterproof, fogproof, and like all Leupold riflescopes, it's designed, machined, and assembled in the USA and covered by the Leupold 30-year guarantee.

Patrol 6HD	RETICLE	Model #	Obj.	Maintube	Weight (grams)	Length (cm)	Eye Relief (mm)	FOV (m @ 100 m)	Elev. Adj. MOA
1-6x24 CDS-ZL2	A	182352	24mm	30mm	380	27,3	94 - 97	40,30 - 6,40	170
1-6x24 Pop-Up Rezero	B	182398	24mm	30mm	380	27,3	94 - 97	40,30 - 6,40	170

All models are Second Focal Plane (SFP). For more information, See page 69.

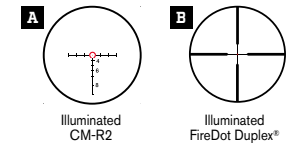

For more information and to see full-size reticles, see pages 69-81.

MARK 5HD™

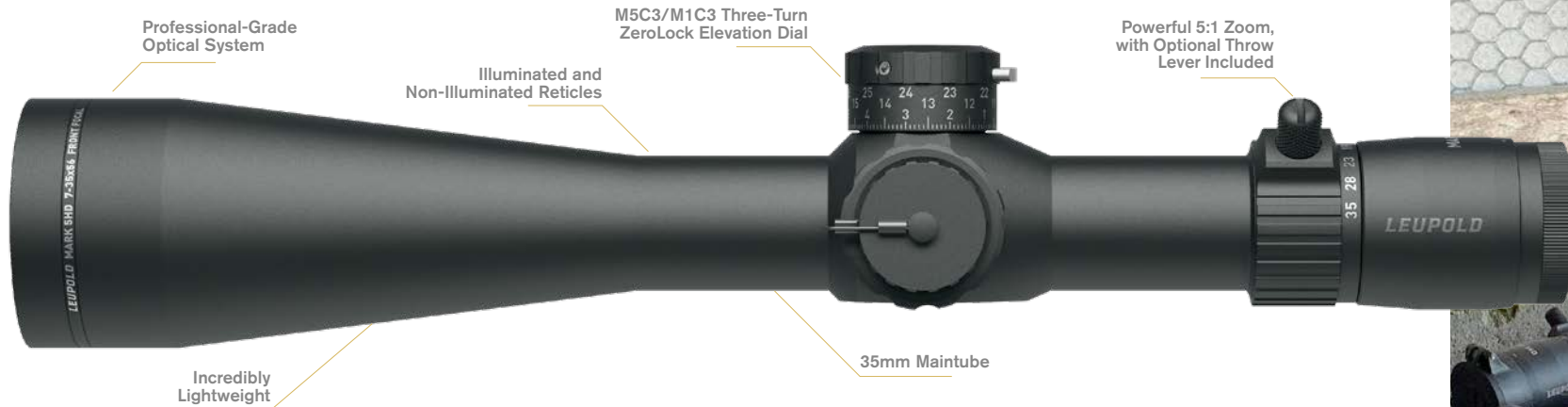
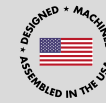

Pick up a Mark 5HD™ and you'll feel the difference: it's up to 567 grams lighter than other scopes in its class. Get behind one and you'll see the difference, from the superior edge-to-edge clarity and extreme low-light performance, to the versatility of the PR2™ reticle. With three revolutions of elevation adjustment, the Mark 5HD was built to max out the performance of the latest long-range rifles and ammo. Ergonomically designed with more tactile, audible click adjustments, larger numbers, and a high-speed throw lever so you can put accurate fire downrange faster.

Mark 5HD	RETICLE	Model #	Obj.	Maintube	Weight (grams)	Length (cm)	Eye Relief (mm)	FOV (m @ 100 m)	Elev. Adj. MOA		
3.6-18x44 M5C3 Front Focal	A	173296	44mm	35mm	737	30,6	90 - 97	9,77 - 1,93	100		
	B	173297								D	173299
	C	173298								E	173301
	F	176811								K	180725
		J	180726								
3.6-18x44 M5C3 Front Focal CW UP/R Adjustments	A	173300	F	176812							
3.6-18x44 M1C3 Front Focal	I	176445	H	176446							
5-25x56 M5C3 Front Focal	A	171772	56mm	35mm	850	39,8	91 - 97	6,80 - 1,40	120		
	B	171773								D	171775
	C	171774								E	171776
	J	180609								F	171777
	K	180610								M	180222
5-25x56 M5C3 Front Focal CW UP/R Adjustments	A	171778									
5-25x56 M1C3 Front Focal	H	176449	L	180291							
I	176448										
7-35x56 M1C3 Front Focal	L	180292	56mm	35mm	936	39,8	91 - 97	4,90 - 1,00	100		
7-35x56 M5C3 Front Focal	C	174545	56mm	35mm	936	39,8	91 - 97	4,90 - 1,00	100		
	E	176124								B	174546
	D	177332								F	177333
	A	176594								M	180223
7-35x56 M5C3 Front Focal CW UP/R Adjustments	B	174547									
7-35x56 M1C3 Rear Focal	G	174549	56mm	35mm	936	39,8	91 - 97	5,60 - 1,10	100		

Front Focal = First Focal Plane (FFP)
Rear Focal = Second Focal Plane (SFP)

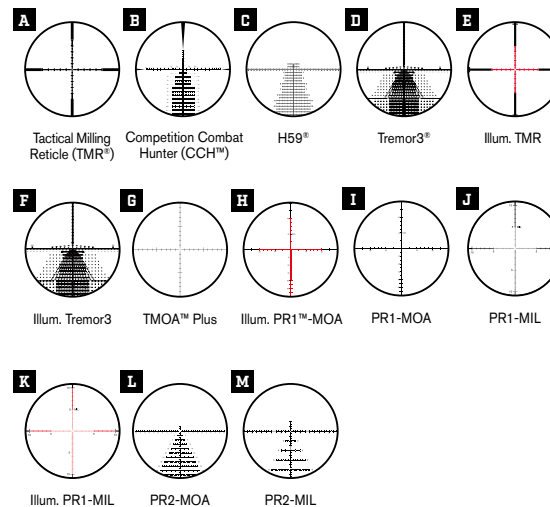

For more information and to see full-size reticles, see pages 69-81.



@ mathias.nn_shooting



MARK 3HD™



Leupold® riflescopes are known for their elite optical performance, and the Mark 3HD™ is no exception. But reaching this level of excellence doesn't happen overnight. For the last 113 years, we've manufactured military-grade optics that outperform and outlast everything else on the market, and we've applied that heritage to a new line of tactical scopes. All Mark 3HD models feature everything you need to get the most out of your long-range, tactical rifle. Complete with MIL-based adjustments, exposed elevation adjustments, HD lenses, and a low-profile power selector ring, this series delivers everything a tactical or long-range shooter could ask for. Under stress, the illuminated FireDot® reticle with eight settings gets you on target fast, even in harsh daylight. And like all Leupold riflescopes, it's designed, machined, and assembled in the USA and covered by the Leupold 30-year guarantee.

Mark 3HD	RETICLE	Model #	Obj.	Maintube	Weight (grams)	Length (cm)	Eye Relief (mm)	FOV (m @ 100 m)	Elev. Adj. MOA
1.5-4x20	A	180670	20mm	30mm	272	23.8	106 - 95	24,73 - 9,80	125
1.5-4x20	B	180662	20mm	30mm	272	23.8	107 - 93	24,73 - 9,80	125
1.5-4x20 P5	D	180664	20mm	30mm	272	23.8	107 - 93	24,73 - 9,80	125
3-9x40	E	180665	40mm	30mm	437	31,5	107 - 93	11,23 - 4,53	52
3-9x40 P5	D	180666	40mm	30mm	437	31,5	107 - 93	11,23 - 4,53	52
4-12x40 P5	D	180668	40mm	30mm	371	30,9	126 - 95	7,17 - 3,37	80
4-12x40 P5 Side Focus	F	180669	40mm	30mm	371	30,9	133 - 96	7,17 - 3,37	80
6-18x50 P5 Side Focus	F	180671	50mm	30mm	482	36,3	129 - 95	2,10 - 1,00	56
8-24x50 P5 Side Focus	F	180674	50mm	30mm	569	37,0	136 - 96	1,60 - 0,80	53

All models are Second Focal Plane (SFP). For more information, See page 69.



Select Mark 3 HD riflescopes come equipped with P5 dials for tactile, audible clicks providing precise 0.1 MIL elevation and windage adjustments.

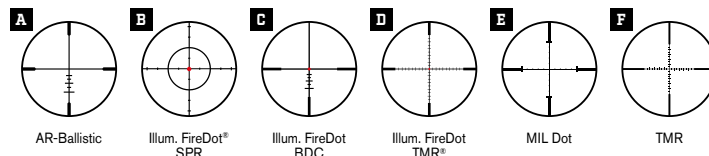

For more information and to see full-size reticles, see pages 69-81.

DELTAPOINT™ PRO



Tool-Less, Top-Loading Battery Exchange is Hassle-Free

Push-Button On/Off with Eight Intensity Settings Supports Modern White Phosphor Equipment*

Slotted 1-MOA Click Adjustments

Optional Integrated Rear Sight is a Fail-Safe Backup

Professional-Grade Red Dot Optical System

At 53.8 Grams, it's Incredibly Tough and Waterproof to 10 Meters

Motion Sensor Technology (MST) Extends Battery Life

*Night Vision Compatible Models Only



The DeltaPoint® Pro is proof that you don't have to compromise performance, even on a small sight. Whether it's topping your AR, shotgun, or pistol, the DeltaPoint Pro gives you the immense, crystal-clear field of view and bold aiming point you need in high-pressure situations. Crafted from aircraft-grade aluminum, this sight is made to handle abuse. The DP-Pro® Night Vision model has improved night vision compatibility to support modern white phosphor equipment. It features new night vision settings with micro-adjustments, and a sleek tactical finish.



Optional Integrated Rear Iron Sight



Night Vision Compatible Models



The DLOC AR Mount is the fastest, easiest, most secure way to mount a DeltaPoint Pro onto your AR. It's a tool-less, quick-mounting, detachable solution that's the ideal height for an AR platform.

DeltaPoint Pro Reflex Sight	RETICLE	Model #	Weight (grams)	Length (cm)	Eye Relief (mm)	Elev. Adj. MOA
1x	A	119688 B 181105	53,8	4,6	Unlimited	60
1x w/AR Mount	A	177156	53,8	4,6	Unlimited	60
1x - Dark Earth	A	175840 B 181106	53,8	4,6	Unlimited	60
1x - Night Vision	A	179585	53,8	4,6	Unlimited	60
1x Night Vision - Dark Earth	A	179586	53,8	4,6	Unlimited	60

NV = Night Vision Compatible

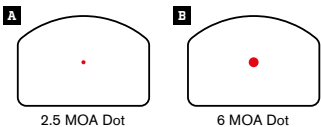



DELTAPOINT MICRO™



The DeltaPoint™ Micro is a fully enclosed, low-profile red dot sight designed specifically for concealed carry and personal defense. Until now, there hasn't been a compact red dot sight suited for pistols with smaller frames and lower sight profiles, but the DeltaPoint Micro changes the game. Mounted directly to the rear sight dovetail, the DeltaPoint Micro sits at the same height as factory iron sights and aligns the red dot with the front sight, giving you faster target acquisition and improved accuracy. And with eight levels of illumination, you can easily adjust the brightness of your red dot to match current conditions. If you need a rugged and reliable red dot for a conceal carry pistol but don't want to deal with replacing factory sights or complicated mounting systems, then the DeltaPoint Micro is for you. Current models fit Glock® and Smith & Wesson® M&P® handguns only.

For Glock®



For Smith & Wesson® M&P®



DeltaPoint Micro Reflex Sight	RETICLE	Model #	Weight (grams)	Length (mm)	Eye Relief (mm)	Elev. Adj. MOA	Wind. Adj. MOA
1x - Glock®	A	178745	31,2	57,1	Unlimited	100	180
1x - S&W® M&P®	A	179570					

A



3 MOA Dot





BX[®]-5 SANTIAM[®] HD



Shadow Gray

Field-Replaceable Eyecups

Generous, Forgiving Eyebow for Long Glassing Sessions

Edge-to-Edge Premium Resolution and Color Fidelity

Easy to Hold Roof Prism Design

Professional-Grade Optical System

Guard-ion Hydrophobic Lens Coating Sheds Water, Dirt, Oil, and Fingerprints

Made for picking out distant targets like Coues deer and sheep, the BX[®]-5 Santiam[®] HD binocular dominates other optics in its class. We designed the generous eyebow for long glassing sessions. The Professional-Grade Optical System ramps up light transmission and redefines low-light performance, clarity, and resolution at extreme long range.

BX-5 Santiam HD	FINISH	Model #	Actual Magnification	Obj. Aperture	Weight (grams)	Length (mm)	Eye Relief (mm)	Linear FOV (m @ 1000 m)	Angular FOV (degrees)
8x42	A	174481	8x	42mm	669	150	18,5	115	7.2
10x42	A	174483	10x	42mm	689	150	16,6	104	6.5
10x50	A	175854	10x	50mm	893	173	19,3	93	5.8
12x50	A	175856	12x	50mm	910	173	16,6	83	4.4
15x56	A	172457	15x	56mm	1276	209	18,0	70	4.4

PRO GEAR ACCESSORIES INCLUDED

The BX-5 Santiam HD binocular comes with Leupold's GO Afield™ shoulder strap, binocular case, lens covers, and a lens cloth.



Tripod Tray included with 15x56 model

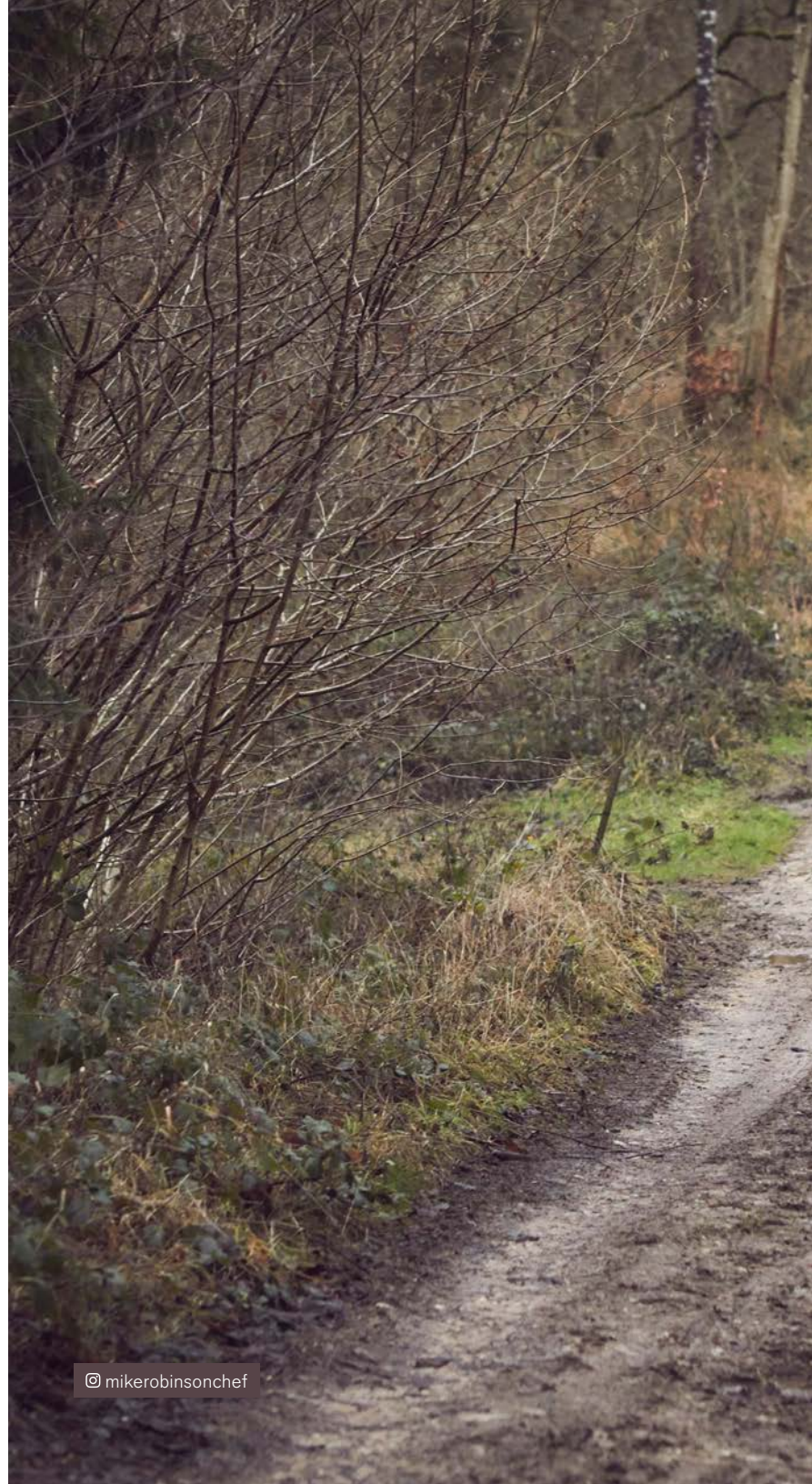

BX-4 PRO GUIDE® HD



Shadow Gray

Field-Replaceable Eyecups

Professional-Grade, Lightweight Performance

Edge-to-Edge Premium HD Resolution

Easy to Hold Roof Prism Design

Professional-Grade Optical System

Guard-ion Hydrophobic Lens Coating Sheds Water, Dirt, Oil, and Fingerprints



For performance that won't weigh you down on long, backcountry hunts, you need the BX[®]-4 Pro Guide[®] HD binoculars. The Professional-Grade Optical System delivers the brightness, edge-to-edge sharpness, and contrast guides demand, and we've taken extra steps to eliminate glare. You won't find a binocular that works better in the worst light or reveals more in those crucial minutes at dawn and dusk.

BX-4 Pro Guide HD	FINISH	Model #	Actual Magnification	Obj. Aperture	Weight (grams)	Length (mm)	Eye Relief (mm)	Linear FOV (m @ 1000 m)	Angular FOV (degrees)
8x32	A	172658	8x	32mm	482	121	16,0	131	7,5
10x32	A	172660	10x	32mm	482	121	16,0	131	7,5
8x42	A	172662	8x	42mm	663	142	19,0	123	7,0
10x42	A	172666	10x	42mm	686	142	16,0	109	6,2
10x50	A	172670	10x	50mm	793	168	18,8	94	5,7
12x50	A	172675	12x	50mm	808	168	16,0	84	4,8

PRO GEAR ACCESSORIES INCLUDED

The BX-4 Pro Guide HD binocular comes with Leupold's GO Afield™ shoulder strap, binocular case, lens covers, and a lens cloth.



BX[®]-4 RANGE HD™ TBR/W

NEW



Shadow Gray

- Twist-up Eyecups
- High light transmission red OLED display
- Right/Left programmable power button
- Easy to Hold Roof Prism Design
- Elite Optical System
- Extra-low dispersion glass



When speed is paramount, there's no substitute for a range-finding binocular. The BX[®]-4 Range HD™ TBR/W 10x42mm fuses our DNA engine and ballistics software with the optical performance diehard hunters and shooters demand. Now you can spot and range targets without wasting valuable seconds switching between gear. Its high-contrast red OLED display delivers visible readouts in any light, and its edge-to-edge clarity makes glassing sessions easy on the eyes. When you're packing for your next match or hunt, cut the excess. Take the BX[®]-4 Range HD™ TBR/W.

BX-4 Range HD TBR/W	FINISH	Model #	Actual Magnification	Obj. Aperture	Weight (grams)	Length (mm)	Eye Relief (mm)	Linear FOV (m @ 1000 m)	Angular FOV (degrees)
10x42	A	182883	10x	42mm	1117	150	16,0	111	6,1

Gold = New Products

PRO GEAR ACCESSORIES INCLUDED

The BX-4 Range HD TBR/W binocular comes with binocular harness, lens covers, and a lens cloth.





BX-2[®] ALPINE[®] HD



Shadow Gray

Field-Replaceable Eyecups

Precision Focus Adjustments

Easy to Hold Roof Prism Design

Lightweight Magnesium Body

Elite Optical System



Whether it's your first binocular or your 50th, your glass needs to give you a bright image, feel comfortable in your hands, and be able to take a beating. The BX-2 Alpine[®] HD binocular checks all of these boxes and more. It's perfect for any glass-and-go scenario. With our Elite Optical System, this bino offers excellent dawn-to-dusk light transmission for a bright image when it matters most, elite-level glare reduction in harsh light, and the resolution and clarity that diehard hunters and shooters demand. And like all Leupold[®] binoculars, it's covered by the Leupold 30-year guarantee.

BX-2 Alpine	FINISH	Model #	Actual Magnification	Obj. Aperture	Weight (grams)	Length (mm)	Eye Relief (mm)	Linear FOV (m @ 1000 m)	Angular FOV (degrees)
8x42	A	181176	8x	42mm	689	127	18,0	118	7.4
10x42	A	181177	10x	42mm	683	127	15,0	104	6.5
10x52	A	181178	10x	52mm	865	137	18,0	85	5.9
12x52	A	181179	12x	52mm	859	137	15,0	80	5

PRO GEAR ACCESSORIES INCLUDED

The BX-2 Alpine HD binocular comes with Leupold's GO Afield™ Harness, lens covers, and a lens cloth.



BX-1 MCKENZIE HD



The BX-1 McKenzie® HD reveals more details than other binoculars in its class. The BX-1 McKenzie HD delivers class-leading low-light performance with our Advanced Optical System, which delivers the light transmission, glare reduction, and resolution all recreational sportsmen and sportswomen demand. Its lightweight, compact design is waterproof and purpose-built to handle the harshest conditions. And like all Leupold® binoculars, it's covered by the Leupold 30-year guarantee.

BX-1 McKenzie HD	FINISH	Model #	Actual Magnification	Obj. Aperture	Weight (grams)	Length (mm)	Eye Relief (mm)	Linear FOV (m @ 1000 m)	Angular FOV (degrees)
8x42	A	181172	8x	42mm	623	149	17	107	6,1
10x42	A	181173	10x	42mm	623	149	12	102	5,8
10x42 MOOBL	B	182852	10x	42mm	623	149	12	102	5,8
10x50	A	181174	10x	50mm	765	165	17	87	5,0
12x50	A	181175	12x	50mm	765	165	12	80	4,6

Gold = New Products

PRO GEAR ACCESSORIES INCLUDED

The BX-1 McKenzie HD binocular come with Leupold's GO Afield™ Harness, lens covers, and a lens cloth.



BX-1 ROGUE COMPACT



BX-1 Rogue® Compacts are at home in the field, at the game, and everywhere people want to get close to the action. The porro prism design delivers clarity and brightness that never disappoints.

BX-1 Rogue Compact	FINISH	Model #	Actual Magnification	Obj. Aperture	Weight (grams)	Length (mm)	Eye Relief (mm)	Linear FOV (m @ 1000 m)	Angular FOV (degrees)
8x25 Compact	A	59220	8x	25mm	360	109	15,0	112	6,4
10x25 Compact	A	59225	10x	25mm	360	109	15,0	96	5,6

ACCESSORIES INCLUDED

The BX-1 Rogue Compact binocular comes with a neoprene carrying case, shoulder strap, lens covers, and a lens cloth.









GOLD RING® 20-60x80



Folded Light Path System
Delivers Best-In-Class
Optical Performance

Generous Eyebow for
Extended Glassing Sessions

First Focal Plane Impact™ Reticle
(Optional)

Exceptional Clarity at
All Magnification Settings

Wide Field of View — Up to
40 Meters at 1000 Meters

Prismless Optical System for True
Color and Superior Light Transmission



Reach out to extreme long range and glass with the resolution, contrast, and color fidelity you need to find game in any conditions. Even in low light, this spotting scope achieves a level of resolution that's a major advantage. Add the optional Impact Reticle, and you get an MOA scale in the front focal plane for fast and accurate shot calling and trophy measurement at any magnification.

Gold Ring	Model #	Actual Magnification	Obj. Aperture	Weight (grams)	Length (mm)	Eye Relief (mm)	Linear FOV (m @ 1000 m)	Angular FOV (degrees)
20-60x80	120376	20x - 60x	80mm	1752	390	30,0 - 30,0	40 - 14	2,3 - 0,8
20-60x80 (with Impact Reticle)	120377	20x - 60x	80mm	1752	390	30,0 - 30,0	40 - 14	2,3 - 0,8

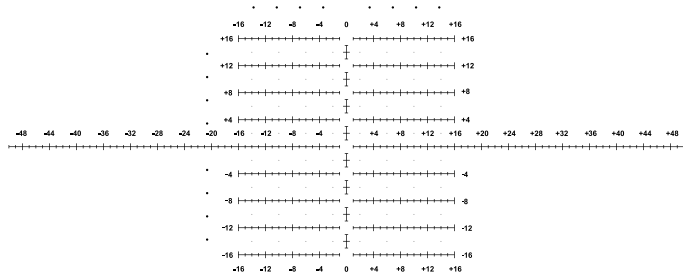

LEUPOLD'S IMPACT™ RETICLE

Using this MOA-based, front focal plane reticle, a guide or spotter can call impacts and offer the shooter immediate corrections. When combined with accurate ranges from an RX series rangefinder, hunters can measure antler spreads before taking a shot. A MOA-based grid set in the lower half of the viewing field allows for fast and accurate measurements across the entire magnification range. With the additional milliradian dots, hunters can use the Impact Reticle with MIL-based reticles, too. Available in Gold Ring® 12-40x60 HD and 20-60x80 spotting scopes.

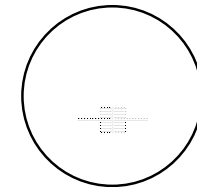

GOLD RING® 12-40x60



Proven performance, outstanding image quality, wide field of view, best in class eye relief, and compact size: Our Gold Ring® 12-40x60 spotting scope has it all. Choose the 12-40x60 HD with high-definition lenses for even sharper details at maximum magnification. Leupold's unique Folded Light Path System uses mirrors rather than a heavy prism to create a more compact, lightweight design. This system also handles abuse better than prism systems, making it ideal for hunters.

Gold Ring	Model #	Actual Magnification	Obj. Aperture	Weight (grams)	Length (mm)	Eye Relief (mm)	Linear FOV (m @ 1000 m)	Angular FOV (degrees)
12-40x60	120371	12x - 40x	60mm	1049	315	30,0 - 30,0	56 - 17	3,2 - 1,0
12-40x60 HD	120372	12x - 40x	60mm	1049	315	30,0 - 30,0	56 - 17	3,2 - 1,0
12-40x60 HD (with Impact Reticle)	120373	12x - 40x	60mm	1049	315	30,0 - 30,0	56 - 17	3,2 - 1,0

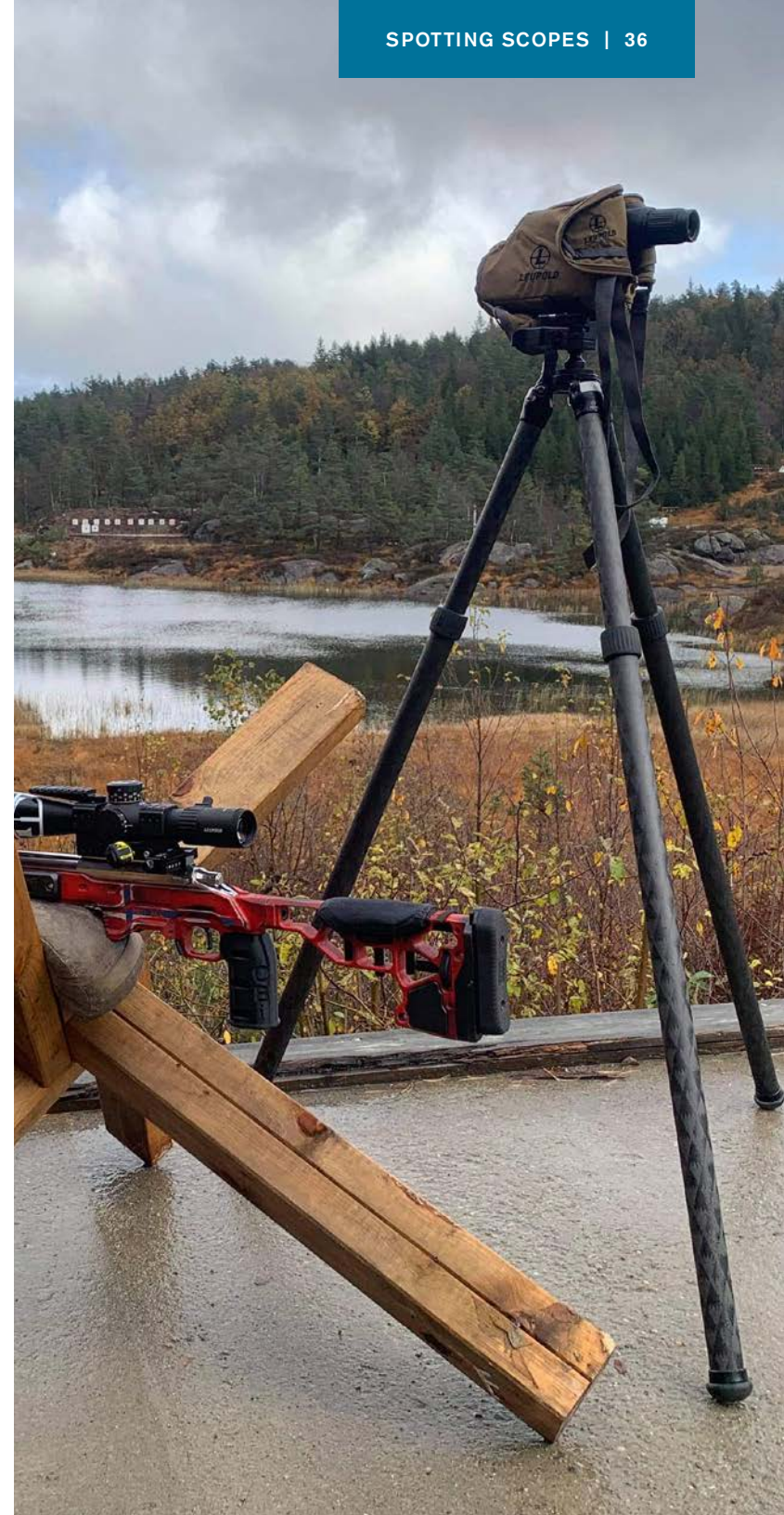



GOLD RING[®] COMPACT



Durable Carbon Fiber Housing for Lightweight Strength

Use Handheld, with a Tripod, or Walking Stick

15-30x50 Compact



Generous Eyebbox for Extended Glassing Sessions

Performance Equal to Much Larger Optics

Extreme Compact Design

Patented Side Focus for Smooth, Steady Image Refinement



10-20x40 Compact

Gold Ring[®] Compact spotting scopes lighten your load while delivering performance and features that rival larger models. Carbon fiber construction keeps them ultralight and incredibly tough, and the Elite Optical System ensures a vivid, sharp image.

Gold Ring Compact	Model #	Actual Magnification	Obj. Aperture	Weight (grams)	Length (mm)	Eye Relief (mm)	Linear FOV (m @ 1000 m)	Angular FOV (degrees)
10-20x40 Compact	120374	10x - 20x	40mm	447	191	18,5 - 17,2	66 - 45	3,8 - 2,6
15-30x50 Compact	120375	15x - 30x	50mm	610	279	17,5 - 17,1	45 - 30	2,6 - 1,7

MARK 4[®] TACTICAL

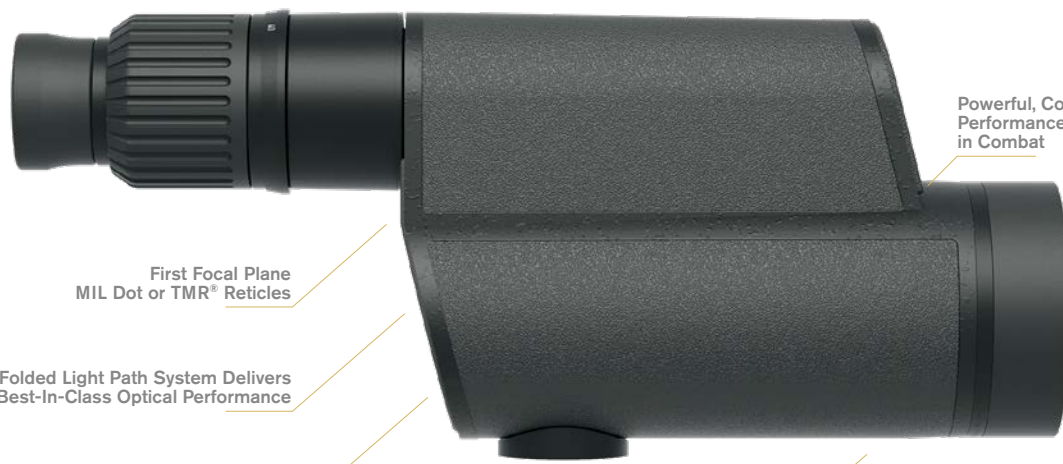

Powerful, Compact
Performance Proven
in Combat

First Focal Plane
MIL Dot or TMR[®] Reticles

Folded Light Path System Delivers
Best-In-Class Optical Performance

Universal Mount — Standard
1/4-20 Thread Tripod Attachment

Digital Camera Compatibility
Ideal for Surveillance

The Mark 4[®] Tactical spotting scope gives you the brightness and clarity necessary for positive target identification in any conditions. Built to survive shocks, blows, drops, and impacts, it's not only tough, it's also waterproof and fogproof. Countless military sniper teams have trusted the Mark 4 Tactical spotting scope. You can depend on it, too.

Mark 4 Tactical	Model #		Actual Magnification	Obj. Aperture	Weight (grams)	Length (mm)	Eye Relief (mm)	Linear FOV (m @ 1000 m)	Angular FOV (degrees)
12-40x60	A 53756	B 60040	12x - 40x	60mm	1049	315	30,0 - 30,0	56 - 18	3,2 - 1,0
	C 67185	E 182942							
	D 110183								
	A 110825	E 110826							
20-60x80	A 110825	E 110826	20x - 60x	80mm	1752	390	30,0 - 30,0	40 - 14	2,3 - 0,8

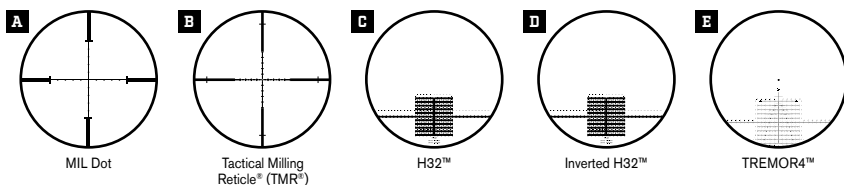

A MIL Dot

B Tactical Milling Reticle[®] (TMR[®])

C H32[™]

D Inverted H32[™]

E TREMOR4[™]

For more information and to see full-size reticles, see pages 69-81.

Inverted reticles allow spotting scope
to be mounted upside-down on the tripod.





SX™-5 SANTIAM® HD



Redefining top-tier spotting scopes, the SX™-5 Santiam® HD delivers the relentless performance die-hard hunters and shooters demand. A generous eyepiece provides premium edge-to-edge clarity and unmatched sharpness and definition. With Leupold's Professional-Grade Optical System, the SX-5 Santiam HD delivers unmatched light transmission that's designed to outperform in the most challenging lighting conditions, industry-leading glare reduction for a clear image in harsh, direct light, and the resolution and clarity that professional guides and shooters demand in the field. The SX-5 Santiam HD also features a rugged, yet lightweight armor for maximum protection in the harshest conditions.

SX-5 Santiam HD	Model #	Actual Magnification	Obj. Aperture	Weight (grams)	Length (mm)	Eye Relief (mm)	Linear FOV (m @ 1000 m)	Angular FOV (degrees)
27-55x80 Straight	175912	27x - 55x	80mm	1948	381	16,6 - 19,2	32 - 22	2,0 - 1,4
27-55x80 Angled	175911	27x - 55x	80mm	1948	381	16,6 - 19,2	32 - 22	2,0 - 1,4



STRAIGHT EYEPIECE

The SX-5 Santiam HD is also available with a straight eyepiece.

SX™-4 PRO GUIDE® HD

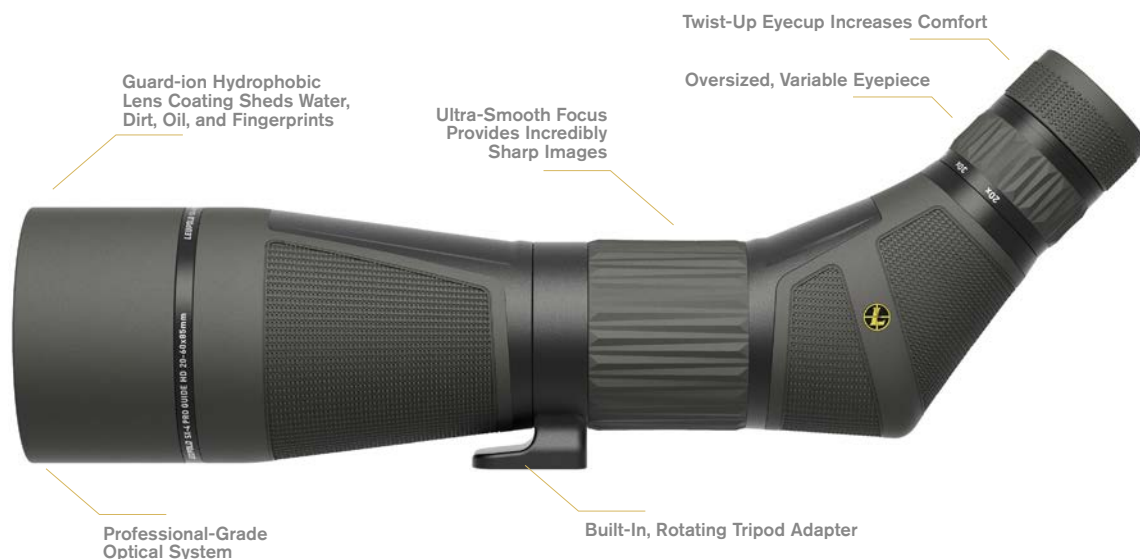

Built to take on the harshest conditions, this spotter is a must have for any serious hunter or shooter. It features an incredibly rugged magnesium body that is waterproof and fogproof, an oversized eyepiece that provides all-day comfort. With Leupold's Professional-Grade Optical System, the SX™-4 Pro Guide HD® delivers unmatched light transmission that's designed to outperform in the most challenging lighting conditions, industry-leading glare reduction for a clear image in harsh, direct light, and the resolution and clarity that professional guides and shooters depend on in the field. And like all Leupold® spotting scopes, the SX-4 Pro Guide HD is covered by the Leupold 30-year guarantee. Whether you're going on your first big game hunt or helping repeat clients tag out year after year, this spotter should be in your kit.

SX-4 Pro Guide HD	Model #	Actual Magnification	Obj. Aperture	Weight (grams)	Length (mm)	Eye Relief (mm)	Linear FOV (m @ 1000 m)	Angular FOV (degrees)
20-60x85 Angled	177597	20x - 60x	85mm	2218	452,0	19,0-17,8	30,56-16,88	1,8-1,0
20-60x85 Straight	177598	20x - 60x	85mm	2218	460,0	19,0-17,8	30,56-16,88	1,8-1,0
15-45x65 Angled	177599	15x - 45x	65mm	1760	360,0	20,0-17,6	43,6-22,7	2,5-1,3
15-45x65 Straight	177600	15x - 45x	65mm	1760	368,0	20,0-17,6	43,6-22,7	2,5-1,3



STRAIGHT EYEPIECE

The SX-4 Pro Guide HD is also available with a straight eyepiece.



SX™-2 ALPINE® HD



Built for the harshest conditions, the Leupold® SX™-2 Alpine® HD is a must have for all serious hunters or shooters. It's incredibly rugged and 100 percent waterproof and fogproof. It features an oversized eyepiece that allows for comfortable all-day glassing, and Leupold's Professional-Grade Optical System, which delivers the light transmission, glare reduction, and resolution that professional guides and shooters demand. Whether you're spending the day at the range or heading out for your first big game hunt, the SX-2 Alpine HD should be in your kit.

SX-2 Alpine HD	Model #	Actual Magnification	Obj. Aperture	Weight (grams)	Length (mm)	Eye Relief (mm)	Linear FOV (m @ 1000 m)	Angular FOV (degrees)
20-60x60 Angled	180143	20x - 60x	60mm	1700	365	16,7 - 19,5	35,6 - 16,9	2,04 - 0,97
20-60x80 Angled	180144	20x - 60x	80mm	1900	426	19,5 - 18,0	34 - 16	1,92 - 0,93





LEUPOLD = LONG RANGE INTELLIGENCE

Accuracy, distance, and ballistics set Leupold® rangefinders above the rest. You'll get accuracy within 0.5 meters, no matter what type of target you're ranging. Best-in-class light transmission for elite optical performance makes finding your target easier than ever. Don't let a competitive rangefinder's straight-line distance or "rifleman's rule" calculations ruin your next hunt. Leupold's True Ballistic Range® (TBR®) offers a real ballistic solution. Put accuracy, distance, and TBR together and you get more than a measurement. You get long-range intelligence.

FIRST-SHOT SUCCESS STARTS WITH LEUPOLD

Hunt long enough and you're going to encounter a long-distance uphill or downhill shot. This is exactly why you need a Leupold RX rangefinder with True Ballistic Range — to take into account the angle of your shot and your rifle's ballistics to put you dead on. Line-of-Sight measurements won't put you on target. Any other rangefinder, even one with an inclinometer, won't give you an accurate range to your target, because they use basic trigonometry to calculate a straight-line horizontal distance (i.e. "rifleman's rule").

TRAJECTORY MATTERS



Read the fine print: some competitive rangefinders actually warn you not to use them at distances greater than 365 meters. We'll go so far to say it's irresponsible to shoot game at long range with anything but a RX rangefinder. Here's why.

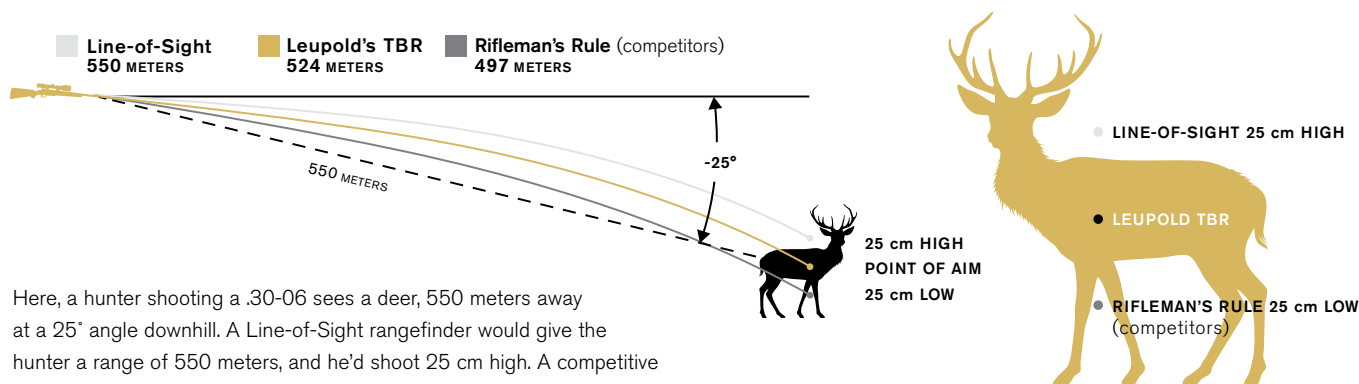

Here, a hunter shooting a .30-06 sees a deer, 550 meters away at a 25° angle downhill. A Line-of-Sight rangefinder would give the hunter a range of 550 meters, and he'd shoot 25 cm high. A competitive rangefinder with an inclinometer using "rifleman's rule" would give him a range of 497 meters, and he'd shoot 25 cm low. His RX rangefinder would give him the True Ballistic Range of 524 meters for a clean kill.

TBR/W ADDS THE WIND FACTOR

True Ballistic Range/Wind is the easiest way to account for wind out to distances of 725 meters. TBR/W generates a hold point for a 5 m/s wind at a 90° angle to your direction of aim.

ALPHA IQ® AND DNA® RANGING ENGINES

Whether you're using a rangefinder with Leupold's new Alpha IQ ranging engine or DNA engine (Digitally eNhanced Accuracy), you'll be accurate to within 0.5 meters on any target no matter its color or texture. Alpha IQ takes rangefinder intelligence to the next level. Improved pulse rate, signal-to-noise ratio, and intelligent signal processing make target acquisition lightning quick with excellent freehand ranging stability. Alpha IQ also builds upon our industry-leading target color resolution for improved accuracy on long-range readings.

TAKE A MEASURE WITH TROPHY SCALE

With Leupold Trophy Scale, you can accurately measure the size of the animal you're looking at. Enter the width/height you want to use as a baseline — for example, 75 cm. Range a red deer, and your RX rangefinder will display hashmarks spaced to that width for that distance. Bracket an animal's antlers between the marks to determine how close the rack is to your benchmark width (see the example below). To measure height, simply turn the rangefinder on its side and repeat the process. Trophy Scale is invaluable in states such as Alaska, where animals are legal based on spread and not just points.

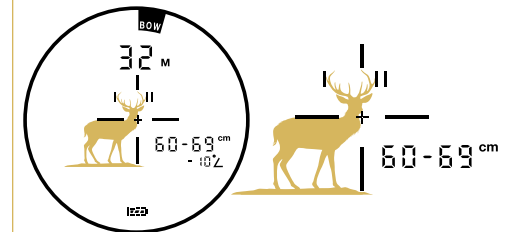

The benchmark settings here are 60 to 69 cm, and the red deer being ranged is closer to the 60 cm mark. The RX rangefinder automatically adjusts the hashmarks based on the range; in this case, 32 meters.

RX-2800 TBR®/W



The latest long-range rifles and ammunition go farther than ever. The RX-2800 TBR®/W goes way, way out there, too. Powered by Alpha IQ®, it ranges farther, faster, and more accurately than any other rangefinder you can carry. At 7x, it's also the most powerful Leupold® rangefinder, with the optical performance you need to pick out distant game.



RX-2800 TBR/W	FINISH	Model #	Actual Magnification	Reflective Range (m)	Weight (grams)	Dimensions (cm)	Eye Relief (mm)	Linear FOV (m @ 1000 m)
RX-2800 TBR/W	A	171910	7x Monocular	2550	224	L: 10,9 / H: 7,4 / W: 3,8	16,0	110



Black



RX-1600i TBR/W



The RX®-1600i TBR®/W with DNA® is a workhorse ready for any hunt. It delivers the farthest, most accurate ranging in its class — out to 1450 meters — and uses our True Ballistic Range/Wind for greater first-shot success. It doesn't matter if you're carrying a rifle or a bow this season, you'll want to carry an RX-1600i TBR/W, too.



RX-1600i TBR/W with DNA	FINISH	Model #	Actual Magnification	Reflective Range (m)	Weight (grams)	Dimensions (cm)	Eye Relief (mm)	Linear FOV (m @ 1000 m)
RX-1600i TBR/W with DNA	A	173805	6x Monocular	1450	221	L: 9,7 / H: 7,1 / W: 3,3	17,0	105



Gray/Black

RX-1500i TBR/W



Know the exact distance of your next shot with the RX-1500i TBR/W rangefinder. Loaded with the features that professional hunters and shooters demand, this rangefinder gets rid of the guesswork with the push of a button. The RX-1500i TBR/W meets the needs of both archers and riflemen by using our lightning-fast DNA® laser engine and our True Ballistic Range®/ Wind (TBR®/W) technology to turn out precisely calculated ranges in the most extreme terrain.



RX-1500 TBR/W	FINISH	Model #	Actual Magnification	Reflective Range (m)	Weight (grams)	Dimensions (cm)	Eye Relief (mm)	Linear FOV (m @ 1000 m)
RX-1500i TBR/W	A	182443	6x Monocular	1,372	198	L: 102 / H: 64 / W: 38	17,5	105



Gray/Black

RX-1400i TBR/W



The RX-1400i TBR/W Gen 2 enters the market as the most feature-rich rangefinder in its class. With our proprietary DNA® laser engine and an exceptionally bright red display, this rangefinder will give you fast, accurate, and visible readings every time. Its True Ballistic Range/ Wind technology delivers custom shoot-to distances based on your rifle cartridge, and its Flightpath feature indicates possible arrow obstructions when you're hunting with a bow. All this functionality comes wrapped up in an incredibly rugged, lightweight polymer housing, making the RX-1400i TBR/W the perfect choice for your next big adventure.



RX-1400i TBR/W	FINISH	Model #	Actual Magnification	Reflective Range (m)	Weight (grams)	Dimensions (cm)	Eye Relief (mm)	Linear FOV (m @ 1000 m)
RX-1400i TBR/W with DNA	A	179640	5x Monocular	1280	170	L: 9,6 / H: 7,3 / W: 3,3	16,2	112

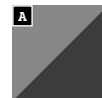

Gray/Black

RX-FULLDRAW® 5



Your bow is custom-built to you, so your rangefinder should be, too. The RX-FullDraw® 5 combines the lightning-fast accuracy of Leupold's DNA® engine with the acclaimed Archer's Advantage™ software, making it the most ballistically advanced rangefinder on the market. Using your personal ballistics, shot distance, and angle compensation, the RX-FullDraw 5 calculates laser-accurate ranges based on your specific gear. Loaded with features designed for the modern archer, like Flightpath™ technology, we take the guesswork out of achieving the perfect shot every time.



RX-FullDraw 5 with DNA	FINISH Model #	Actual Magnification	Reflective Range (m)	Weight (grams)	Dimensions (mm)	Eye Relief (mm)	Linear FOV (m @ 1000 m)
RX-FullDraw 5 with DNA	A 182444	6x Monocular	1100	212	L: 97 / H: 74 / W: 33	17	107



Green/Black







BECNARA™



The Becnara™ fuses Leupold performance with everyday style. Polarized, rugged, and incredibly clear; they will never let you down. Any day or any adventure, the Becnara stands out in the field.

Becnara	Part Number	Rx-Ready	Polarized	Frame Fit	100% UVA Protection	100% UVB Protection
Matte Black/Tortoise, Bronze Mirror	179101	•	•	Regular-Wide	•	•
Matte Black/Gloss Black, Shadow Gray Flash	179102	•	•	Regular-Wide	•	•
Matte Black, Bronze Mirror	179103	•	•	Regular-Wide	•	•
Matte Tortoise, Blue Mirror	179632	•	•	Regular-Wide	•	•
Dark Gray, Shadow Gray Flash	182677	•	•	Regular-Wide	•	•

Gold = New Products

NEW

BRIDGER™



We built the Bridger performance eyewear to keep up with competitors like you. Wherever you go, and whatever you do, its ballistic-rated, In-Fused polarized lenses will eliminate glare so you can focus on your next step.

Refuge	Part Number	Rx-Ready	Polarized	Frame Fit	100% UVA Protection	100% UVB Protection
Matte Black, Shadow Gray Flash	182672	•	•	Narrow-Regular	•	•
Matte Tortoise, Bronze Mirror	182673	•	•	Narrow-Regular	•	•
Dark Gray, Blue Mirror	182674	•	•	Narrow-Regular	•	•
Matte Black, Bronze Mirror	182675	•	•	Narrow-Regular	•	•

Gold = New Products

CHEYENNE™



181280



181281

The Cheyenne features a low-profile frame that makes it the perfect option for hunters and shooters with smaller faces. Its full wrap design offers complete protection from the elements, while maintaining maximum visibility and air flow. If you want eyewear that looks and feels great without sacrificing safety, the Cheyenne is the pair for you.

Cheyenne	Part Number	Rx-Ready	Polarized	Frame Fit	100% UVA Protection	100% UVB Protection
Matte Black, Shadow Gray Flash	181280	•	•	Narrow-Regular	•	•
Tortoise, Bronze Mirror	181281	•	•	Narrow-Regular	•	•

KATMAI™



179097



179098



182676

NEW



179099

The Katmai™ is the choice for any adventurer. Lightweight, rugged, and exceptionally clear; they can be trusted to keep your eyes fresh and your vision true.

Katmai	Part Number	Rx-Ready	Polarized	Frame Fit	100% UVA Protection	100% UVB Protection
Matte Black, Shadow Gray Flash	179097	•	•	Narrow-Regular	•	•
Matte Tortoise, Bronze Mirror	179098	•	•	Narrow-Regular	•	•
Matte Black, Emerald Mirror	179099	•	•	Narrow-Regular	•	•
Dark Gray, Shadow Gray Flash	182676	•	•	Narrow-Regular	•	•

Gold = New Products

PACKOUT™

NEW

SENTINEL™



179094



179095



179096



179630



182669



182670



182671

The Packout™ is the go-to option for any hunter or shooter. Our proven optical clarity make the Packout perfect for every adventure and everyday wear.

Your sight is worth protecting. The Sentinel performance eyewear meets MIL-PRF-32432A impact standards and guards your eyes with a swappable shatterproof lens. If you're a competitive shooter or defender of the peace, the Sentinel is vital to your kit.

Packout	Part Number	Rx-Ready	Polarized	Frame Fit	100% UVA Protection	100% UVB Protection
Matte Tortoise, Bronze Mirror	179094	•	•	Regular	•	•
Matte Black, Emerald Mirror	179095	•	•	Regular	•	•
Matte Black, Shadow Gray Flash	179096	•	•	Regular	•	•
Matte Tortoise, Blue Mirror	179630	•	•	Regular	•	•

Refuge	Part Number	Rx-Ready	Polarized	Frame Fit	100% UVA Protection	100% UVB Protection
Matte Black, Shadow Gray Flash	182669	•	•	Narrow-Regular	•	•
Matte Black, Laser Safe	182670	•	•	Narrow-Regular	•	•
Matte Tan, Bronze Mirror	182671	•	•	Narrow-Regular	•	•

Gold = New Products

SWITCHBACK™

TRACER™



179091



179092



179093



179629

Comfortable on the range, in the field, or on the ride home, the Switchback™ will quickly become a favorite addition to your everyday kit. Lightweight comfort, and unquestionable clarity gives you everything you need and nothing you don't.

Switchback	Part Number	Rx-Ready	Polarized	Frame Fit	100% UVA Protection	100% UVB Protection
Matte Tortoise, Bronze Mirror	179091	•	•	Regular-Wide	•	•
Matte Black, Shadow Gray Flash	179092	•	•	Regular-Wide	•	•
Matte Black, Emerald Mirror	179093	•	•	Regular-Wide	•	•
Matte Gray, Blue Mirror	179629	•	•	Regular-Wide	•	•



179089



179090



When you're a dedicated shooter, the Tracer™ is an absolute must-have. Interchangeable lenses (included), and weather-resistant coatings are combined with Leupold's unmatched clarity and durability.

Tracer	Part Number	Rx-Ready	Polarized	Frame Fit	100% UVA Protection	100% UVB Protection
Matte Black, Shadow Gray	179089			Narrow-Regular	•	•
Shadow Tan, Bronze Mirror	179090		•	Narrow-Regular	•	•



GO AFIELD™ BINOCULAR HARNESS



This rugged, feature-rich harness will keep your binoculars and small accessories safe, secure, and accessible. Nonelastic, adjustable harness webbing keeps the pouch secure against your body. #172543

GO AFIELD™ BINOCULAR CASE

Keep your binoculars ready with a case you wear over your shoulder, on your belt, and can open one-handed. Water-resistant, 600D nylon construction.
 #172614 Small / For 25-32mm Binoculars
 #172615 Medium / For 42mm Binoculars
 #172616 Large / For 50-56mm Binoculars



OPTICS GO GEAR DUFFLE

When it's time to hit the road, the Optics GO Gear Duffel is the bag to reach for. Its weather-resistant, modular design protects and stores everything from riflescopes to your backcountry cook kit. This duffel features 360 degrees of padding, a loop-lined interior, and a set of removable hook-backed dividers to organize your gear. On the top of the bag, two tripod attachment straps will hold any Leupold tripod, so you'll always have one hand free when you're on the move. #182402



Shown with Pro Guide Rangefinder Pouch (Sold Separately)

PRO GUIDE® BINOCULAR HARNESS 2

Keep your binoculars secured inside our new Pro Guide Binocular Harness 2. Enjoy improved all day comfort in the field with upgraded mesh straps. Ample storage is provided by a front zippered elastic pocket, two elastic side pouches, and a rear cell phone pocket. Fits all current Leupold binoculars except the 15-power BX-5 Santiam HD. #181882

PRO GEAR STRETCH ZIP POUCH



- #182657 Small
- #182658 Medium
- #182659 Large

PRO GEAR RIPSTOP ZIP POUCH



- #182660 Small
- #182661 Medium
- #182662 Large

PRO GUIDE® RANGEFINDER POUCH

The Leupold Pro Guide Rangefinder Pouch is designed for silent operation featuring a magnetic fold-down lid and a fleece-lined interior. Its structured webbing fastens directly to the Pro Guide Bino Harness 2 and can also be attached to belts and MOLLE. #182415



Leupold.com
See the full lineup of Leupold® Pro Gear at Leupold.com.

NEW

PRO GUIDE® SEMI AUTO HOLSTER

The Pro Guide Semi-Auto Holster attaches to belts, MOLLE, and the bottom of the Pro Guide Binocular Harness 2. This adjustable holster fits a wide variety of semi-auto handguns and small revolvers, so whatever firearm you conceal, you'll be able to take it with you on your next hunt or hike. #183578



PRO GUIDE® ZIPPERED ACCESSORY POUCH

Designed to add storage to the Pro Guide Binocular Harness 2, this pouch will carry the odds and ends that often get misplaced in the field. Its 1" structured webbing can also be attached to belts and MOLLE. #183555



NEW

NEW

PRO GUIDE® BEAR SPRAY POUCH

The next time you head into bear country, arm yourself with a fully loaded Pro Guide Bear Spray Pouch. With 1" structured webbing, it straps to belts, MOLLE, and the Pro Guide Binocular Harness 2, allowing you to lock it down wherever you find most convenient. #183554



PRO GEAR BAGS	Color	SKU
GO Afield™ Binocular Harness XF	Shadow Tan / Gray	172543
GO Afield™ Binocular Case (Small)	Shadow Tan / Gray	172614
GO Afield™ Binocular Case (Medium)	Shadow Tan / Gray	172615
GO Afield™ Binocular Case (Large)	Shadow Tan / Gray	172616
Pro Guide Binocular Harness 2	Shadow Tan / Gray	181882
Optics GO Gear Duffle	Shadow Tan / Gray	182402
Pro Guide Zippered Accessory Pouch	Gray / Shadow Tan	183555
Pro Guide Bear Spray Pouch	Gray / Shadow Tan	183554
Pro Guide Semi Auto Holster	Gray / Shadow Tan	183578
Pro Gear Stretch Zip Pouch S	Shadow Gray / Shadow Tan	182657
Pro Gear Stretch Zip Pouch M	Shadow Gray / Shadow Tan	182658
Pro Gear Stretch Zip Pouch L	Shadow Gray / Shadow Tan	182659
Pro Gear Ripstop Zip Pouch S	Black / Shadow Tan	182660
Pro Gear Ripstop Zip Pouch M	Black / Shadow Tan	182661
Pro Gear Ripstop Zip Pouch L	Black / Shadow Tan	182662

QUICK STEM BINOCULAR TRIPOD ADAPTER

Lightweight and slim design make tossing it in your pack easy even when space is at a premium. Quick-release button detaches your binoculars fast. Tough and dependable aluminum body stands up to abuse without losing tension. Arca-Swiss compatible base secures your binoculars to any Leupold tripod with no adapter plate needed.

#182417



FIELD CLAMP BINOCULAR TRIPOD ADAPTER

Clamp design quickly attaches to any binoculars 20-56mm in diameter. Aluminum body stands up to abuse without losing tension. Non-marring rubber pads on inside of clamp won't damage binoculars. Arca-Swiss compatible base secures your binoculars to any Leupold tripod with no adapter plate needed.

#182418



SHOOTING SADDLE

Leupold's Shooting Saddle is an ultra-light, tripod-mounted rifle rest that delivers the stability, speed, and versatility you need for accuracy in any position. You can mount it to any tripod plate using 1/4 20 or 3/8 16 adapter screws.

#181303



NEW

PRO GEAR PANHEAD



Tough and dependable 6061-T6 aluminum body. Arca-Swiss mounting plate provides maximum cross-platform versatility. Friction control handle eliminates jerky movements. #183550

NEW

PRO GEAR WINDOW MOUNT

Tough and dependable 6061-T6 aluminum body. Non-marring rubber pads ensure a firm grip that won't leave scratches. Large locking knob makes tightening and loosening the mount fast and easy. #183551



BINOCULAR TRIPOD TRAY

Instantly mount nearly any size binoculars to a tripod and lock them down quickly and securely with the hook-and-loop strap. The tray is tough, lightweight, and attaches to any tripod with a 1/4-20 mount. Covered by the Leupold 30-year guarantee. #172625



MOUNTING TOOL

Includes a slotted screwdriver, two Torx® drivers, and five hex-head drivers. #52296



CARBON FIBER TRIPODS

Leupold's Carbon Fiber Tripods deliver maximum versatility and performance to hunters and shooters alike, with a rugged, lightweight design that's ready to go anywhere. The Mark 5 is built to mount to a rifle, and is perfect for competition shooters and predator hunters. The Pro Guide is meant for long periods of glassing and is sturdy enough to shoot from while maintaining a compact, lightweight design. The ultra-lightweight Alpine is designed for backcountry hunters and offers a tough, minimalist solution that's easy to carry on the go.

Mark 5 CF-455 Tripod Kit #182796

Pro Guide CF-436 Tripod Kit #180379

Alpine CF-425 Tripod Kit #180380



SCOPE COVER

Protect your Leupold from dirt and damage to keep it looking like new. Made from water-resistant, nylon-laminated neoprene.



MARK 5HD® COMPETITION SPEED DIAL

#182645



LENSPEN

Features a retractable brush and a self-replenishing microfiber cleaning tip. #48807



ALUMINA®

Leupold® Alumina® products feature precision-machined aluminum for lighter weight and durability. You can get Alumina flip-back lens covers, lens shades, anti-reflection devices (ARD™), rubber eyepiece guards, or a 15.2 m focus adapter.



Flip-Back Lens Covers



Anti-Reflection Devices



Lens Shades

RING WRENCH

#48762



LEUPOLD DECALS

Show everyone what's at your core with these Leupold vehicle decals made from white, weatherproof vinyl. Three sizes: 13 cm, 31 cm or 79 cm.

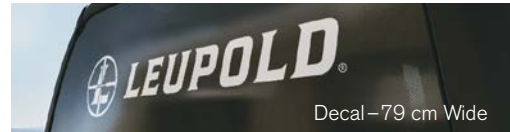

Decal - 79 cm Wide



LEUPOLD

Decal - 31 cm Wide



LEUPOLD

Decal - 13 cm Wide

ACCESSORIES

BINOCULAR AND SPOTTING SCOPE ACCESSORIES	PART NO.
Binocular Tripod Adapter Tray	172625
Leupold Binocular Tripod Adapter (Fits all Leupold binoculars)	118660
Pro Guide Binocular Harness 2	181882
Tripod Panhead	183550
Window Mount Clamp	183551
Field Clamp	182418
Quick Stem	182417
Shooting Saddle	181303
CARBON FIBER TRIPODS	PART NO.
Mark 5 CF-455 Tripod Kit	182796
Pro Guide CF-436 Tripod Kit	180379
Alpine CF-425 Tripod Kit	180380
SCOPE COVERS	PART NO.
Small	53572
Medium	53574
Large	53576
X-Large	53578
XX-Large	53580
LEUPOLD ACCESSORIES	PART NO.
Mark 5HD Competition Speed Dial	182645
LensPen	48807
Mounting Tool	52296
Ring Wrench	48762
Torx Screw Kit	52395
Dealer Parts Kit	63040
Leupold Decal Vertical 12,7 cm - White	172618
Leupold Decal Horizontal 30,5 cm - White	172619
Leupold Decal Large Horizontal 78,7 cm - White	172620

ALUMINA ACCESSORIES

ALUMINA ACCESSORIES	Finish & Part No.
FLIP-BACK LENS COVERS	Matte
Flip-Back Lens Cover - 56mm (VX-5HD, VX-6, VX-6HD, Mark 5HD)	119737
Flip-Back Lens Cover - 52mm (VX-5HD, VX-6, VX-6HD, Mark 5HD)	117610
Flip-Back Lens Cover - 50mm	59050
Flip-Back Lens Cover - 44mm (VX-5HD, VX-6, VX-6HD, Mark 5HD)	117608
Flip-Back Lens Cover - 42mm (VX-5HD, VX-6, VX-6HD, Mark 5HD)	117607
Flip-Back Lens Cover - 40mm	59045
Flip-Back Lens Cover - 36mm	59040
Flip-Back Lens Cover - 33mm	59035
Flip-Back Lens Cover - 28mm	58755
Flip-Back Lens Cover - 24mm	114756
Flip-Back Lens Cover - 20mm	59030
Flip-Back Lens Cover - Standard EP	59055
Flip-Back Lens Cover - Small EP	59060
Flip-Back Lens Cover - Large EP (VX-5, VX-6)	117611
Flip-Back Lens Cover Kit - 40mm & Standard EP	62990
Flip-Back Lens Cover Kit - 50mm & Standard EP	62995
LENS SHADES FOR POST-2004 SCOPES	Matte
10,2 cm - 45mm Lens Shade Competition Series	54180
6,4 cm - 50mm Lens Shade	52350
10,2 cm - 50mm Lens Shade	52353
6,4 cm - 40mm Lens Shade	56187
10,2 cm - 40mm Lens Shade	56190
7,6 cm - 42mm Lens Shade	118768
7,6 cm - 44mm Lens Shade	118769
7,6 cm - 50mm Lens Shade (Fits VX-6HD)	118770
7,6 cm - 52mm Lens Shade	118771
7,6 cm - 56mm Lens Shade	118772
ARD (Anti-Reflection Device)	Matte
ARD (Anti-Reflection Device) (pre-2004)	52292
ARD (Anti-Reflection Device) - 30mm	62870
ARD (Anti-Reflection Device) - 36mm	62875
ARD (Anti-Reflection Device) - 40mm	62880
ARD (Anti-Reflection Device) - 50mm	62885
ARD (Anti-Reflection Device) - 60mm	62955
15,2 METER FOCUS ADAPTER	Gloss
Threaded 15,2 Meter Focus Adapter (Post-2004)	59021

MOUNTING SYSTEMS



RELENTLESS PERFORMANCE STARTS HERE

Your mounting system is the crucial link between your firearm and your optic, and it's where accuracy and performance start. For Leupold's steel mounts, it all begins with red-hot, U.S. carbon steel blanks. Leupold® aluminum mounts are machined from aircraft-grade aluminum. This is what it takes to ensure rock-solid repeatable accuracy, shot after shot, year after year. We meticulously machine and polish each mount and after rigorous tolerance testing, we stamp them with the Leupold logo. Like our riflescopes, our mounts are covered by the Leupold 30-year guarantee.

FIND THE RIGHT MOUNT IN SECONDS AT LEUPOLD.COM

Leupold offers an unrivaled selection of rings, mounts, and bases. Yet for every rifle and scope combination, there is one ideal mounting solution. The Leupold Mount Finder at Leupold.com makes finding yours this easy:

1. Select Your Rifle
2. Select Your Rifle Scope
3. Get The One Mount You Need

STANDARD [STD]

RINGS U.S. carbon steel, precision engineered to match all STD bases. Five heights available. Anti-slip grooves eliminate scope movement in the rings.

BASES Available in one-piece and two-piece bases. Two-piece steel bases fit right-hand and left-hand actions (available in front and rear reversible). Maximum accessibility to breech area. Front base locks a dovetail ring in place. Rear base with windage ring allows for gross left/right boresighting correction using the mounts. Rear ring secured by Nylok™ windage adjustment screws for perfect boresight windage. Long-Range STD mounts add 1/4-degree (15-MOA) of built in elevation.



DUAL DOVETAIL [DD]

One of our strongest systems, designed for the hardest-kicking firearms. The twist-and-lock action ensures a solid connection with the base. Bases accept all Leupold Dual Dovetail rings.



EXTENSION RINGS

For STD, DD, or QR bases (1" or 30mm). Adds an additional 15.9 mm of fore-and-aft ring spacing.



QUICK RELEASE [QR]

Quickly remove and reattach your scope, and return to within half a minute of angle of the original point of impact. Solid, carbon steel.



LEUPOLD RINGMOUNTS

A premium alternative for Ruger®, CZ®, Sako®, and other rifles requiring ringmounts. They're also a no-tap mounting option for most .22 rimfire rifles with an 11mm, 13mm, or 9.5 mm dovetail rail. Machined from solid steel for superior tolerances and integrity.



CROSS-SLOT *

QRW2

(Quick Release-Rings Weaver Style)



PRW2

(Perma-Rings Weaver Style)



LRW

(Leupold Rings Weaver Style)



We've updated the proven cross-slot design of these steel rings to be stronger and to give them more contact with the base for added stability and easier installation.

These rugged, forged-steel rings feature anti-slip grooves that eliminate scope movement.

BACKCOUNTRY

All BackCountry mounts are machined from 7075-T6 aircraft-grade aluminum for a lifetime of lightweight, rugged performance.

RINGMOUNTS

When ounces matter as much as performance, this is the mount you need.



CROSS-SLOT BASES

Fits both picatinny and Weaver-style rings. Available with zero elevation or 20-MOA for long-range shooting.



CROSS-SLOT RINGS*

This updated cross-slot ring design has more contact with the base for even greater stability.



OPEN RANGE CROSS-SLOT *

The Open Range cross-slot ring design is machined from 6061 aluminum and delivers lightweight, rugged performance you can rely on.



HANDGUN BASES

Built to withstand the crushing recoil of modern handguns. Available for many popular models.



BASES FOR CUSTOM GUNMAKERS

With Leupold's Gunmaker line of bases, you can configure your mount to your exact specifications. Engineered for Leupold STD rings.



RIFLEMAN®

These low-cost mounting solutions are machined from rugged and lightweight aircraft-grade aluminum. Bases fit most rifle models. Match with your choice of detachable or vertical split rings in low, medium, or high.



* Leupold cross-slot rings will fit on all picatinny and Weaver bases.

MARK 4® RINGS

Machined, aircraft-grade aluminum or U.S. carbon steel. Can be installed on any AR/MSR platform or any firearm with a picatinny-style base.



MARK 4 8-40 ADAPTABLE BASES

The rugged, 8-40 screws increase mount strength by 41%. Also available in a 20-MOA Long-Range Shooter model that can accommodate both the 8-40 screw and a modified 6-48 shoulder screw for greater mounting flexibility. Fits Winchester® PBR™, Remington® Super Magnum™, H-S Precision®, and other 8-40 rifles without modification.

Note: Some firearms will not work with these adaptable mounts. Check current offering for details.



MARK 4 AR-15/M16 HANDLE MOUNT

Reliably attach your scope to any M16 variant with a carrying handle.
#52136



MARK AR®

The monolithic, cantilever design is strong and durable under the most intense conditions. The integral base/ring affixes securely to a picatinny rail. Preset ring spacing for easy mounting; mark one location on the rail for fast remounts and accurate return to zero. Available in 1", 30mm, 34mm, 34mm 20-MOA, and 35mm.



MARK IMS

The Leupold Integral Mounting Systems (IMS) family quickly and easily eliminates the two most common issues faced when mounting standard riflescopes to AR-style rifles; scope height and eye relief. All Leupold IMS products are tested to endure the rigors of the field and are covered by the Leupold 30-year guarantee.

Available in 34mm, 34mm 20-MOA, 35mm, and 35mm 20-MOA.



CANTILEVER



BOLT ACTION

DELTAPOINT® PRO MOUNTS



DOVETAIL MOUNTS

Provides secure installation for DeltaPoint Pro on a wide variety of handguns.



45° MOUNT

Easily attaches directly to Picatinny rails at a 45° angle. Fits DeltaPoint Pro red dot sight only. #173236



CROSS-SLOT MOUNT

For installation on picatinny rails and Weaver-style bases. #120056



AR MOUNT

Specifically designed for mounting the DeltaPoint Pro on AR-style firearms. #177154



RINGTOP MOUNT

Attach the DP Pro to any of our Mark 4® rings or Mark IMS mounting systems. Run it up top or at either side at a 45 degree angle.



RIFLESCOPE SPECIFICATIONS

RIFLESCOPE

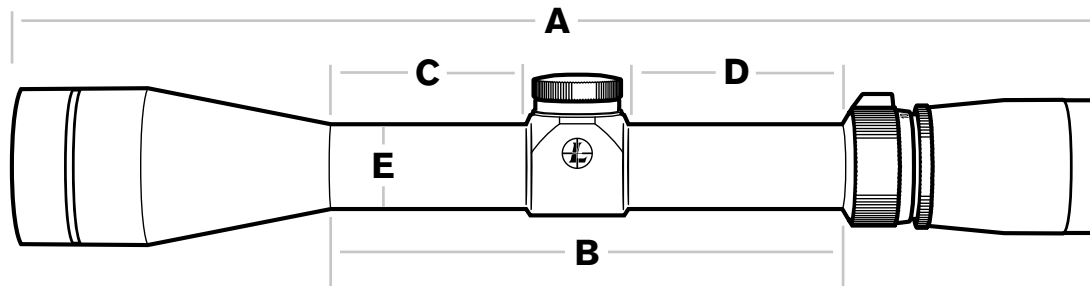

EXTERIOR FINISHES

MATTE BLACK

The standard in low-reflective finish to match any firearm.

BURNT BRONZE

This standard Cerakote finish is a cocoa bronze highlighted by gold metallic.

To determine which finishes are available for a specific scope, refer to the charts featured on the individual product pages.

¹ On scopes with straight objective tubes, dimension "C" is measured from the forward edge of the turret housing to the gold ring.

² Dimension "A" may vary according to the focusing position of the eyepiece.

³ Actual eye relief on the 2.5-8x Handgun is between 305 to 686 mm on 2.5x and between 356 and 432 mm on 8x.

⁴ w/ adj. covers, w/o lens shade. Other configuration weights are: w/o adj. covers or lens shade: 552.8 g; w/o adj. covers, w/ lens shade: 606.7 g; w/ adj. covers and lens shade: 629.4 g.

* BDC (Bullet Drop Compensation) Dial.

** Elevation and windage adjustment ranges are the distance from one extreme of the adjustment to the other.

	SPECIFICATIONS												Elevation Adjustment Type	Windage Adjustment Type
	Dimensions (cm unless otherwise stated)					Field of View (m @ 100 m)		Optimum Eye Relief (mm)		Weight	Elevation Travel**	Windage Travel**		
	A ²	B	C ¹	D	E	Low	High	Low	High	Grams	MOA	MOA		
VX-6HD ILLUMINATED RETICLE														
1-6x24 CDS-ZL2 Side Focus (includes metric)	27,3	17,2	7,2	6,5	30mm	40,30	6,40	94	97	459	170	170	1/4-MOA	1/4-MOA
2-12x42 CDS-ZL2	31,9	14,2	4,3	6,5	30mm	18,83	3,20	94	97	564	120	120		
3-18x44 Side Focus CDS-ZL2	34,4	13,7	3,4	6,6	30mm	12,77	2,13	94	97	612	75	75		
3-18x50 Side Focus CDS-ZL2 (includes metric)	34,4	13,5	3,2	6,6	30mm	12,77	2,13	94	97	649	75	75		
4-24x52 Side Focus CDS-ZL2	37,2	15,8	5,4	6,7	34mm	9,37	1,60	94	97	720	75	75		
4-24x52 Side Focus CDS-TZL3	37,2	15,8	5,4	6,7	34mm	9,37	1,60	94	97	723	75	75		
VX-5HD														
1-5x24 Illum. Reticle (metric) Pop Up Re-zero Dial	27,3	17,2	7,2	6,5	30mm	41,07	8,12	94	97	388	170	170	1/4-MOA	1/4-MOA
1-5x24 CDS-ZL2 Illum. Reticle	27,3	17,2	7,2	6,5	30mm	41,07	8,12	94	97	417	170	170		
2-10x42 Pop Up Re-zero Dial	31,9	14,2	4,3	6,5	30mm	18,82	3,92	94	97	507	120	120		
2-10x42 CDS-ZL2 Illum. Reticle	31,9	14,2	4,3	6,5	30mm	18,82	3,92	94	97	536	120	120		
3-15x44 Side Focus CDS-ZL2	34,4	13,7	3,4	6,6	30mm	12,77	2,74	94	97	558	75	75		
3-15x44 Side Focus CDS-ZL2 Illum. Reticle	34,4	13,7	3,4	6,6	30mm	12,77	2,74	94	97	558	75	75		
3-15x56 Side Focus CDS-ZL2 Illum. Reticle (includes metric)	34,5	13,5	3,2	6,6	30mm	12,77	2,74	94	97	629	75	75		
4-20x52 Side Focus CDS-ZL2	37,3	15,7	5,3	6,6	34mm	8,66	2,35	94	97	658	110	75		
4-20x52 Side Focus CDS-ZL2 Illum. Reticle	37,3	15,7	5,3	6,6	34mm	8,66	2,35	94	97	723	110	75		
4-20x52 Side Focus CDS-TZL3	37,3	15,7	5,3	6,6	34mm	8,66	2,35	94	97	675	110	75		
7-35x56 Side Focus CDS-TZL3	39,6	17,6	7,1	6,9	34mm	4,97	0,95	94	97	728	55	40		

RIFLESCOPE SPECIFICATIONS

	SPECIFICATIONS													Elevation Adjustment Type	Windage Adjustment Type
	Dimensions (cm unless otherwise stated)					Field of View (m @ 100 m)		Optimum Eye Relief (mm)		Weight	Elevation Travel**	Windage Travel**			
	A ²	B	C ¹	D	E	Low	High	Low	High	Grams	MOA	MOA			
VX-3HD															
1.5-5x20 CDS-ZL	24,7	15,2	5,8	6,3	1"	22,53	8,03	112	92	286	125	125	1/4-MOA	1/4-MOA	
1.5-5x20 CDS-ZL Illuminated	24,3	14,7	5,3	6,3	30mm	22,53	8,03	112	92	354	125	125			
2.5-8x36 CDS-ZL	29,0	13,3	4,0	6,3	1"	12,50	4,57	112	92	337	65	65			
3.5-10x40 CDS-ZL	32,2	15,1	5,7	6,3	1"	9,67	3,67	112	92	371	55	55			
3.5-10x40 CDS-ZL	32,2	15,1	5,7	6,3	30mm	9,67	3,67	112	92	411	75	60			
3.5-10x50 CDS-ZL	31,2	13,5	4,0	6,3	1"	9,90	3,67	112	92	422	75	60			
3.5-10x50 CDS-ZL	31,2	13,5	4,0	6,3	30	9,90	3,67	112	92	501	75	60			
4.5-14x40 CDS-ZL	32,2	15,1	5,7	6,3	1"	6,63	2,47	112	92	377	70	70			
4.5-14x40 Side Focus CDS-ZL	32,2	15,1	5,7	6,3	30mm	6,63	2,47	112	92	442	95	75			
4.5-14x40 CDS-T	32,2	15,1	5,7	6,3	30mm	6,63	2,47	112	92	442	95	75			
4.5-14x50 CDS-ZL	31,2	13,5	4,0	6,3	1"	6,83	2,53	112	92	425	70	70			
4.5-14x50 CDS-ZL	31,2	13,5	4,0	6,3	30mm	6,83	2,53	112	92	482	95	80			
6.5-20x40 EFR CDS-T	36,8	16,5	7,4	5,8	1"	4,77	1,83	112	92	516	49	49			
6.5-20x50 Side Focus CDS-T	36,5	16,4	7,0	6,3	30mm	4,70	1,93	112	92	589	80	80			
VX-FREEDOM															
1.5-4x20	23,8	13,7	5,5	4,7	1"	24,73	9,80	106	94	272	125	125	1/4-MOA	1/4-MOA	
1.5-4x28 Scout	28,1	11,4	3,5	4,8	1"	13,90	5,77	175	152	272	67	67			
2-7x33	28,0	12,2	4,4	4,7	1"	14,60	9,93	106	94	315	75	75			
2-7x33 Rimfire	28,0	12,2	4,4	4,7	1"	14,60	9,93	106	94	315	75	65			
3-9x33 EFR	29,5	12,1	4,3	4,8	1"	11,03	4,53	106	94	343	65	65			
3-9x40 (all models)	31,5	13,9	5,9	5,0	1"	11,03	4,53	106	94	346	60	60			
3-9x50 CDS	30,7	12,1	5,9	4,8	1"	11,03	4,53	106	94	414	60	60			
3-9x50 Illuminated FireDot	30,7	12,1	5,9	4,8	30mm	11,03	4,53	106	94	483	60	60			
4-12x40 CDS	31,8	12,1	4,0	5,0	1"	7,17	3,33	125	95	371	80	80			
4-12x40 Creedmoor	31,8	13,2	4,8	5,3	1"	7,17	3,33	125	95	371	80	80			
4-12x40 CDS Side Focus	31,2	13,9	6,1	4,8	30mm	6,63	3,73	133	96	445	80	80			
4-12x50 CDS	30,5	11,6	4,0	4,8	1"	7,33	3,50	106	94	439	55	55			
6-18x40 CDS Side Focus	37,1	16,8	8,9	4,8	30mm	4,37	2,27	130	97	482	56	56			
COMPETITION															
VX-4.5HD 1-4.5x24 CDS-ZL2 Service Rifle	27,4	17,3	7,4	6,6	30mm	37,55	7,99	94	97	351	170	170	1/4-MOA	1/4-MOA	
VX-4.5HD 1-4.5x24 CDS-ZL2 Illum. Reticle Service Rifle	27,4	17,3	7,4	6,6	30mm	37,55	7,99	94	97	436	170	170			
FX-4.5HD 4.5x24 CDS-ZL2 Service Rifle	26,7	17,1	7,1	6,3	30mm	8,22	–	80	–	375	170	170	1/4-MOA	1/4-MOA	
Competition Series 45x45 Target	40,4	18,0	8,1	6,4	30mm	0,80	–	81	–	576	40	40	1/8-MOA Target	1/8-MOA Target	
VX-6 7-42x56 Side Focus CDS Target	39,4	17,5	7,1	6,6	34mm	5,40	0,90	107	98	745	65	65	1/8-MOA	1/4-MOA	
FX-3															
6x42	33,5	13,7	5,1	5,6	1"	5,80	–	113	–	386	70	70	1/4-MOA	1/4-MOA	
FX-II															
2.5x20 Ultralight	20,3	14,7	4,6	5,6	1"	13,20	–	124	–	184	147	147	1/4-MOA	1/4-MOA	
FX-I															
4x28 Rimfire	23,4	12,2	3,6	5,6	1"	8,50	–	114	–	213	95	95	1/4-MOA	1/4-MOA	

RIFLESCOPE SPECIFICATIONS

RIFLESCOPE

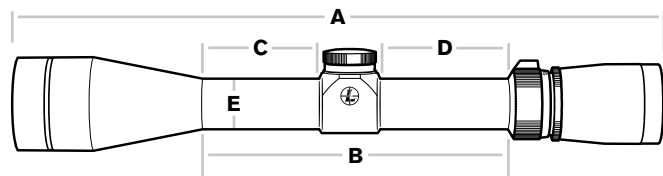

DELTAPOINT PRO

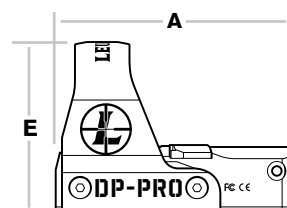

DELTAPOINT MICRO

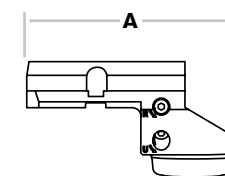

SPECIFICATIONS

	Dimensions (cm unless otherwise stated)					Field-of-view (m @ 100 m)		Optimum Eye Relief (mm)		Weight	Elevation Travel**	Windage Travel**	Elevation Adjustment Type	Windage Adjustment Type
	A ²	B	C ¹	D	E	Low	High	Low	High	Grams	MOA	MOA		
HANDGUN														
FX-II 4x28 Handgun	21,3	10,2	3,6	3,6	1"	3,00	-	457	-	199	110	110	1/4-MOA	1/4-MOA
VX-3 2.5-8x32 Handgun ³	29,0	10,4	3,6	3,8	1"	4,30	1,60	381	381	309	110	110		
PATROL 6HD														
1-6x24 CDS-ZL2	27,3	17,2	7,2	6,5	30mm	40,30	6,40	94	97	380	170	170	1/4-MOA	1/4-MOA
1-6x24														
MARK 5HD														
3.6-18x44 (35mm) M5C3 Front Focal	30,6	15,1	4,3	5,0	35mm	9,77	1,93	90	97	737	100	80	0.1 MIL Click Adjustments	0.1 MIL Click Adjustments
3.6-18x44 (35mm) M5C3 Front Focal Illuminated Reticle	30,6	15,1	4,3	5,0	35mm	9,77	1,93	90	97	737	100	80		
3.6-18x44 (35mm) M1C3 Front Focal	30,6	15,1	4,3	5,0	35mm	9,77	1,93	90	97	737	100	80	1/4-MOA	1/4-MOA
5-25x56 (35mm) M5C3 Front Focal	39,8	15,8	4,9	5,0	35mm	6,80	1,40	91	97	850	120	60	0.1 MIL Click Adjustments	0.1 MIL Click Adjustments
5-25x56 (35mm) M5C3 Front Focal Illuminated Reticle	39,8	15,8	4,9	5,0	35mm	6,80	1,40	91	97	850	120	60		
5-25x56 (35mm) M1C3 Front Focal	39,8	15,8	4,9	5,0	35mm	6,80	1,40	91	97	850	120	60	1/4-MOA	1/4-MOA
7-35x56 M5C3 Front Focal	39,9	15,7	5,0	5,0	35mm	4,90	1,00	91	97	936	100	50	0.1 MIL Click Adjustments	0.1 MIL Click Adjustments
7-35x56 M1C3 Front Focal	39,9	15,7	5,0	5,0	35mm	4,90	1,00	91	97	936	100	50		
7-35x56 M1C3	39,9	15,7	5,0	5,0	35mm	4,90	1,00	91	97	936	100	50	1/4-MOA	1/4-MOA
MARK 3HD														
1.5-4x20	24,2	13,3	5,6	4,6	30mm	24,73	9,80	106	94	341	125	125	0.1 MIL Click Adjustments	0.1 MIL Click Adjustments
1.5-4x20 Illuminated	24,2	13,3	5,6	4,6	30mm	24,73	9,80	106	94	372	125	125		
1.5-4x20 P5	24,2	13,3	5,6	4,6	30mm	24,73	9,80	106	94	380	125	125		
3-9x40 P5	32,3	14,3	6,6	4,6	30mm	11,23	4,53	106	94	426	52	52		
3-9x40 P5 Illuminated	32,3	14,3	6,6	4,6	30mm	11,23	4,53	106	94	448	52	52		
4-12x40 P5 Illuminated	32,3	14,3	6,6	4,6	30mm	7,17	3,37	125	94	454	80	80		
4-12x40 P5 Side Focus	32,1	13,8	6,4	4,6	30mm	7,17	3,37	125	94	460	80	80		
6-18x50 P5 Side Focus	37,1	14,5	6,9	4,6	30mm	2,10	1,00	129	94	553	50	49		
8-24x50 P5 Side Focus	37,1	14,5	6,9	4,6	30mm	1,60	0,80	137	97	570	53	51		
DELTAPOINT PRO														
2.5 MOA Dot	4,6	-	-	-	-	-	-	Unlimited	-	53,8	60	60	Slotted 1 MOA Click Adjustments	Slotted 1 MOA Click Adjustments
6.0 MOA Dot	4,6	-	-	-	-	-	-	Unlimited	-	53,8	60	60		
7.5 MOA Inscribed Delta (Military Only)	4,6	-	-	-	-	-	-	Unlimited	-	53,8	60	60		
DELTAPOINT MICRO														
3.0 MOA Dot	5,7	-	-	-	-	-	-	Unlimited	-	31,2	100	180	Friction - 18 MOA / Revolution	Friction - 36 MOA / Revolution
FREEDOM RDS														
1.0 MOA Dot	13,5	-	-	-	34mm	36,85	7,01	Unlimited	-	196	80	80	1/4-MOA	1/4-MOA



Jakt & Fritid

BINOCULAR/SPOTTING SCOPE SPECIFICATIONS

SPECIFICATIONS																
Available Finishes	Price Range	Erector System Type	Phase Coated	Lens Coatings	Waterproof/Fogproof Technology	Magnification	Linear Field of View m @ 1000 m	Angular Field of View degrees	Weight gram	Length mm	Objective Aperture	Exit Pupil mm	Eye Relief mm	Interpupillary Distance mm	Close Focus Distance m	
BX-5 SANTIAM HD																
8x42	SG	\$\$\$\$	Abbe-Koenig Prism System, Schmidt-Pechan Prism System	Yes	Professional-Grade Optical System	Yes	8x	115	7,2	669	150	42mm	5,0	18,5	58-78	2,4
10x42							10x	104	6,5	689	150	42mm	5,0	16,6	58-74	3,0
10x50							10x	93	5,8	893	173	50mm	5,0	19,3	58-74	3,0
12x50							12x	83	5,2	910	173	50mm	5,2	16,6	58-74	3,0
15x56							15x	70	4,4	1276	209	56mm	3,7	18,0	55-74	3,0
BX-4 RANGE HD																
10x42	SG	\$\$\$	BAK4 Prism	Yes	Professional-Grade Optical System	Yes	10x	109	6,2	686	142	42mm	4,2	16,0	58-74	2,3
BX-4 PRO GUIDE HD																
8x32	SG	\$\$\$	BAK4 Prism	Yes	Professional-Grade Optical System	Yes	8x	131	7,5	482	121	32mm	4,0	16,0	58-74	2,1
10x32							10x	131	7,5	482	121	32mm	4,0	16,0	58-74	2,1
8x42							8x	123	7,0	663	142	42mm	5,3	19,0	58-74	2,4
10x42							10x	109	6,2	686	142	42mm	4,2	16,0	58-74	2,3
10x50							10x	94	5,7	793	168	50mm	4,9	18,8	58-74	3,0
12x50							12x	84	4,8	808	168	50mm	3,9	16,0	58-74	3,0
BX-T HD TACTICAL																
10x42	B	\$\$\$	BAK4 Prism	Yes	Professional-Grade Optical System	Yes	10x	109	6,2	686	142	42mm	4,2	16,0	58-74	2,3
BX-2 ALPINE HD																
8x42	SG	\$\$	BAK4 Prism	Yes	Elite Optical System	Yes	8x	118	7,4	689	127	42mm	5,2	18,0	57-78	4,1
10x42							10x	104	6,5	683	127	42mm	4,1	15,0	57-78	4,1
10x52							10x	85	5,9	865	137	52mm	5	18,0	60-78	3,8
12x52							12x	80	5,0	859	137	52mm	4,2	15,0	60-78	3,8
BX-1 MCKENZIE HD																
8x42	SG MOOBL	\$	BAK4 Prism	Yes	Advanced Optical System	Yes	8x	107	6,1	623	149	42mm	5,0	17,0	56-74	3,0
10x42							10x	102	5,8	623	149	42mm	4,2	12,0	56-74	3,0
10x50							10x	87	5,0	765	165	50mm	5,0	17,0	56-74	2,3
12x50							12x	80	4,6	765	162	50mm	4,0	12,0	56-74	2,5
BX-1 ROGUE COMPACT																
8x25	B	\$	BAK4 Prism	NA	Fully Multi-coated Lens Coating	Yes	8x	112	6,4	360	109	25mm	3,1	15,0	57-71	4,3
10x25							10x	96	5,6	360	109	25mm	2,5	15,0	57-71	4,3
GOLD RING HD																
12-40x60 HD	SG	\$\$\$	Folded Light Path Lens	NA	Professional-Grade Optical System with DiamondCoat 2	Yes	12x - 40x	56 - 17	3,2 - 1,0	1049	315	60mm	4,8 - 1,5	30,0 - 30,0	NA	10,9
GOLD RING																
12-40x60	SG	\$\$\$	Folded Light Path Lens	NA	Elite Optical System with DiamondCoat 2	Yes	12x - 40x	56 - 17	3,2 - 1,0	1049	315	60mm	4,8 - 1,5	30,0 - 30,0	NA	10,9
20-60x80		\$\$\$					20x - 60x	40 - 14	2,3 - 0,8	1752	390	80mm	4,1 - 1,3	30,0 - 30,0	NA	7,6
GOLD RING COMPACT																
10-20x40	SG	\$\$	BAK4 Prims	NA	Advanced Optical System	Yes	10x - 20x	66 - 45	3,8 - 2,6	447	191	40mm	4,0 - 2,0	18,5 - 17,2	NA	1,7
15-30x50							15x - 30x	45 - 30	2,6 - 1,7	610	279	50mm	3,3 - 1,6	17,5 - 17,1	NA	4,1
MARK 4 TACTICAL																
12-40x60	B	\$\$\$	Folded Light Path Lens	NA	Elite Optical System with DiamondCoat 2	Yes	12x - 40x	56 - 18	3,2 - 1,0	1049	315	60mm	4,8 - 1,5	30,0 - 30,0	NA	10,9
20-60x80		\$\$\$\$					20x - 60x	40 - 14	2,3 - 0,8	1752	390	80mm	4,1 - 1,3	30,0 - 30,0	NA	7,6
SX-5 SANTIAM HD																
27-55x80	SG	\$\$\$\$	BAK4 Prism	NA	Professional-Grade Optical System	Yes	27x - 55x	32 - 22	2,0 - 1,4	1948	381	80mm	2,9 - 1,5	16,6 - 19,2	NA	3,3
SX-4 PRO GUIDE HD																
15-45x65	SG	\$\$\$	BAK4 Prism	NA	Professional-Grade Optical System	Yes	15x - 45x	44 - 23	2,5 - 1,3	1760	368	65mm	4,0 - 1,4	20,0 - 17,6	NA	6,7
20-60x85							20x - 60x	31 - 17	1,8 - 1,0	2218	452	85mm	4,1 - 1,4	19,0 - 17,8	NA	10,6
SX-2 ALPINE HD																
20-60x60	SG	\$\$\$	BAK4 Prism	NA	Elite Optical System	Yes	20x - 60x	35,6 - 16,9	2,04 - 0,97	1700	365	60mm	3,0 - 1,0	16,7 - 19,5	NA	10,9
20-60x80							20x - 60x	34 - 16	1,92 - 0,93	1900	426	80mm	4,0 - 1,33	19,5 - 18,0	NA	10,9

B = Black | SG = Shadow Gray | MOOBL = Mossy Oak Original Bottomland

RANGEFINDER SPECIFICATIONS

		RX-2800 TBR/W with Alpha IQ	BX-4 Range HD	RX-1600/ TBR/W with DNA	RX-1500/ TBR/W with DNA	RX-1400/ TBR with DNA	RX-FullDraw 5 with DNA
Available Finishes		B	G	G	GB	GB / MOOB	G
Maximum Range (m) By Target Type		2560 – Reflective 2194 – Trees 1645 – Deer	2377 – Reflective 1463 – Trees 1006 – Deer	1463 – Reflective 1280 – Trees 914 – Deer	1372 – Reflective 1143 – Trees 869 – Deer	1280 – Reflective 1097 – Trees 822 – Deer	1097 – Reflective 1006 – Trees 823 – Deer
Minimum Range	m	5,5	5,5	5,5	5,5	5,5	5,5
Inclinometer		Yes	YES	Yes	Yes	Yes	Yes
TBR (True Ballistic Range)		TBR/W	TBR/W	TBR/W	TBR/W	TBR/W	Archer's Advantage
Measuring Accuracy at Under 114.30 Meters		< 1/2	< 1/2	< 1/2	< 1/2	< 1/2	< 1/2
Display		Illuminated Red OLED Display	High Light Transmission Red OLED Display	Illuminated Red OLED Display	High Light Transmission LCD	Illuminated Red TOLED Display	Illuminated Red OLED Display
Multi-coated Lens System		Yes	Yes	Yes	Yes	Yes	Yes
Scan Mode		Yes	Yes	Yes	Yes	Yes	Yes
Last Target Mode		Yes	Yes	Yes	Yes	Yes	No
Trophy Scale		No	No	No	Yes	No	No
Measurements (Yards / Meters)		Yds/M	Yds/M	Yds/M	Yds/M	Yds/M	Yds/M
Waterproof		Yes	Yes	Yes	Yes	Yes	Yes
Reticle		Plus Point, Duplex, Duplex w/Plus Point	Circle	Plus Point, Duplex, Duplex w/Plus Point	Plus Point, Duplex, Duplex w/Plus Point	Circle, Circle-Plex, Plex	Plus Point, Duplex, Duplex w/Plus Point
Rubber Armor		Armored Grips	Fully Armored	Fully Armored	Armored Grips	Armored Grips	Fully Armored
Diopter Focus		Yes	Yes	Yes	Yes	Yes	Yes
Dimensions (cm)		10,9 x 7,4 x 3,8	15,0 x 13,8 x 7,2	9,7 x 7,1 x 3,3	10,2 x 6,4 x 3,8	9,6 x 7,3 x 3,3	9,7 x 7,1 x 3,3
Weight (with battery)	gram	224	1117	221	198	170	212
Actual Magnification		7x Monocular	10x Binocular	6x Monocular	6x Monocular	5x Monocular	6x Monocular
Linear Field of View	m @ 1,000 m	110	111	105	105	112	107
Angular Field of View (degrees)		6	6.1	6	6	7	6
Objective Aperture (mm)		27,0	42,0	22,0	23,0	21,0	22,0
Exit Pupil (mm)		3,9	4,0	3,6	4,2	4,2	3,6
Eye Relief (mm)		16,0	16,0	17,0	17,5	16,2	17,0
Electronics Warranty		Yes	Yes	Yes	Yes	Yes	Yes

B = Black | GB = Gray/Black | G = Green | MOOBL = Mossy Oak Original Bottomland



LEUPOLD RETICLES

FOCAL PLANES DEFINED

FIRST FOCAL PLANE (FFP)

Reticle size changes in correlation to the magnification setting, allowing for accurate holdovers and range estimations at any power.

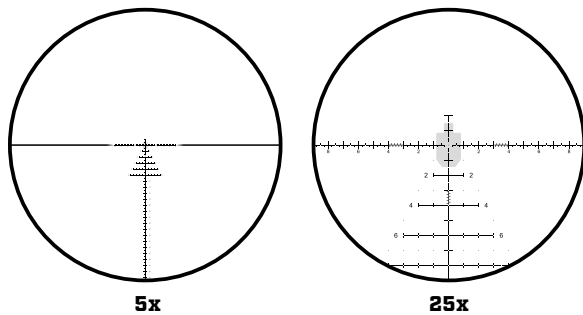

SECOND FOCAL PLANE (SFP)

Reticle size remains constant regardless of the magnification setting. For accurate holdovers and range estimations, the scope must be set to the highest available power.

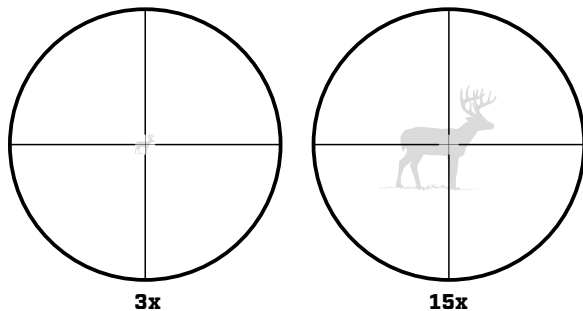

PR1™-MOA

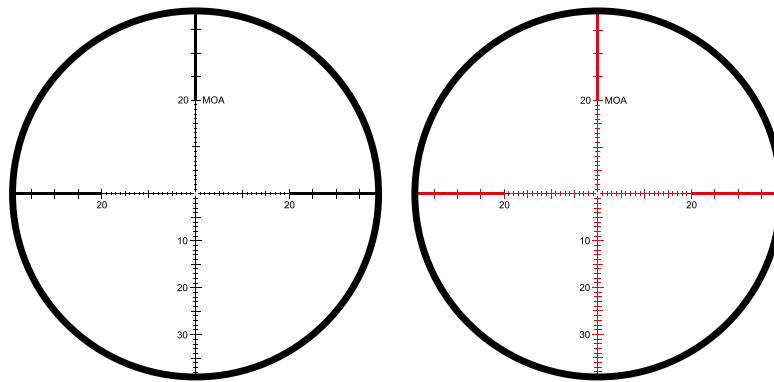

PR1-MIL

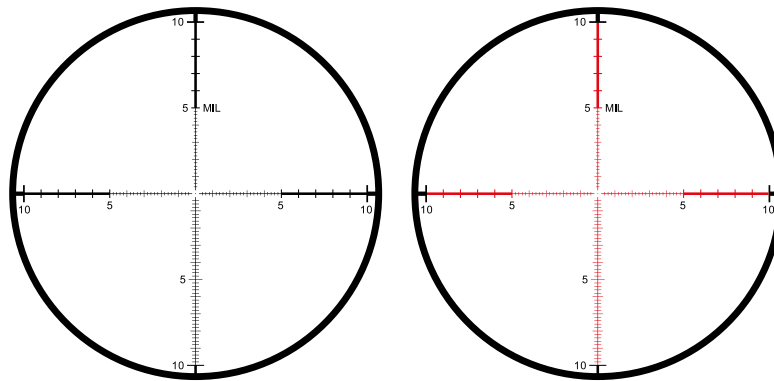

PR2™-MOA

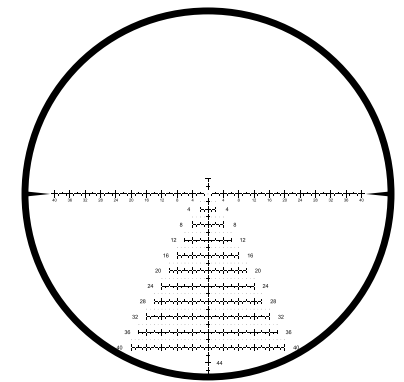

PR2-MIL

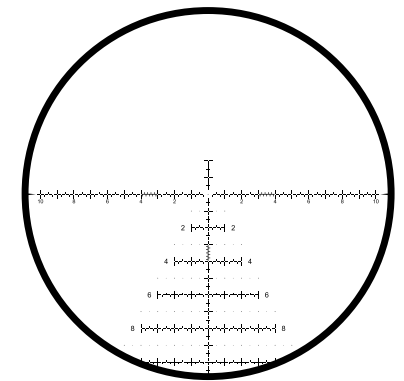

Developed with input from the country's top competitors and professional shooters, the PR2™ reticles are specifically designed for long range speed and precision. Available in either MIL or MOA, the PR2 provides shooters with a clean sight picture free of clutter, allowing for fast accuracy, hold-offs, and shot correction.

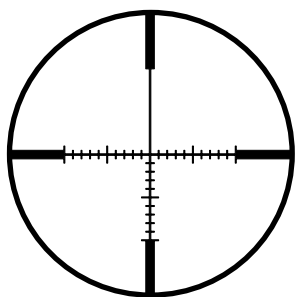

TRI-MOA

This reticle's job is filling tags. Hash marks in 1 MOA increments give you precise reference points for quick, accurate shots. The upper portion of the Tri-MOA reticle is clear for easier scanning and observation. Compatible with any caliber rifle.

RIMFIRE-MOA

Stretch your rimfire rifle's legs out to 183 meters and more. The vertical hash marks are set for rimfire rifle ballistics at 1 MOA increments.

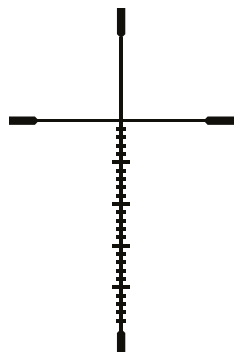
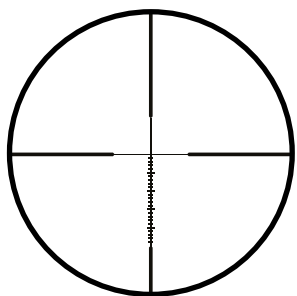

ULTIMATESLAM™

Get close in or extend your reach with hold points from 46 to 274 meters. Excellent for muzzleloaders and shotguns as well as centerfire rifles.

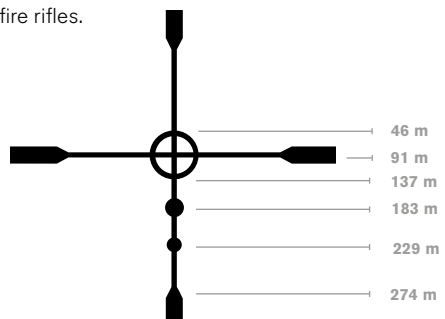
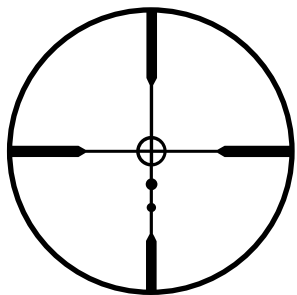

(muzzleloader drop values)

COMBAT COMPETITION HUNTING (CCH™)

Combat, competition, and hunting have one thing in common: moving targets at unpredictable distances. The Combat Competition Hunting reticle is a MIL-based grid developed with input from Tier 1 operators to overcome these challenges. The tapered posts center your eye for rapid engagements. Open intersections allow for target identification at extreme long range. Use the chevrons to lead and range moving targets. Optimized for 12-16x magnification and for use with night vision/thermal optics.

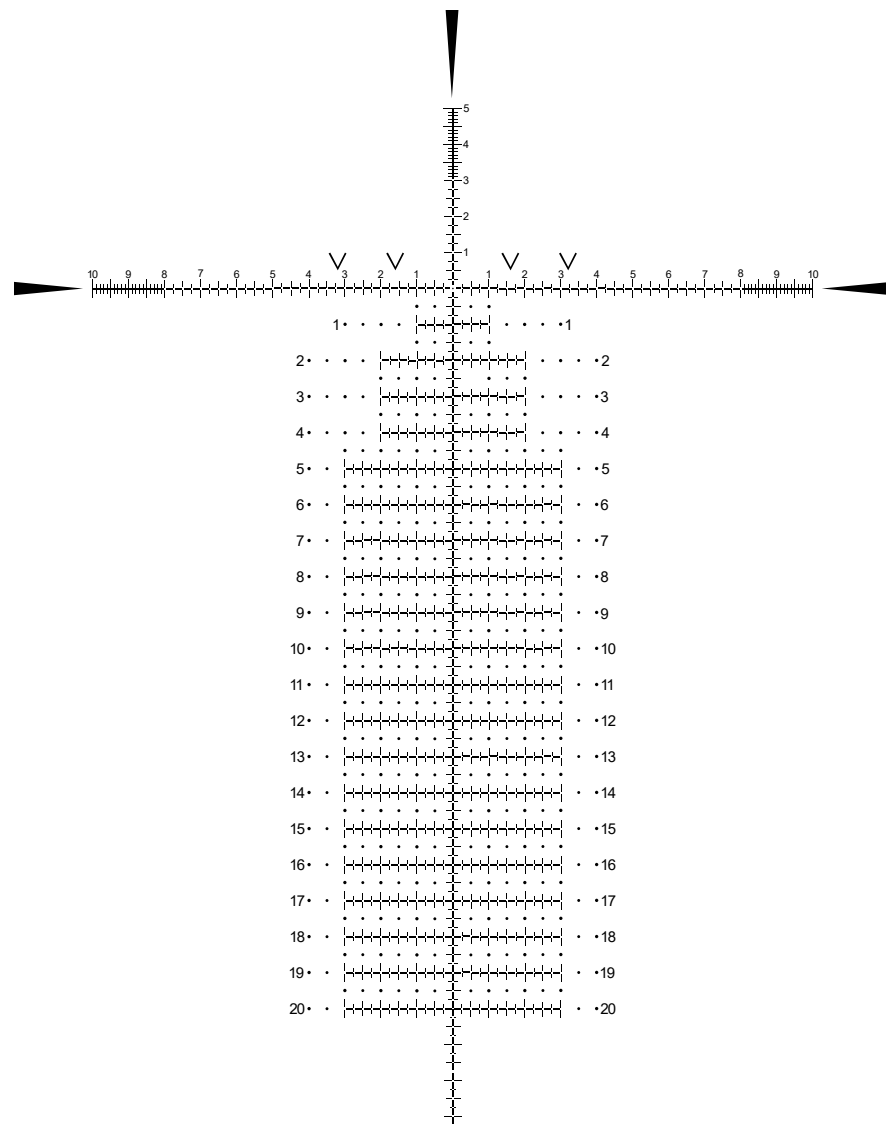

BALLISTICS AIMING SYSTEM® RETICLES

Accurate, long-range shooting is one of the most difficult hunting skills to master. Leupold's answer is to apply science to the art of shooting. Ballistics Aiming System® (BAS) reticles provide a series of aiming points that eliminate guesswork and get you on target fast, so you can confidently place shots at long range. With the right BAS reticle, you'll have the tool to make the shot when that once-in-a-lifetime opportunity steps into view.

Unlike other range-compensating reticles, the calculations made here are incredibly simple. The most important thing is practice.

BOONE AND CROCKETT® *

This was the first optical product to bear the Boone and Crockett Club® name. You get a Duplex® aiming point with Converging Post Crosshair (CPC) style hold points and power selector ballistics tuning. Available in illuminated and non-illuminated versions.

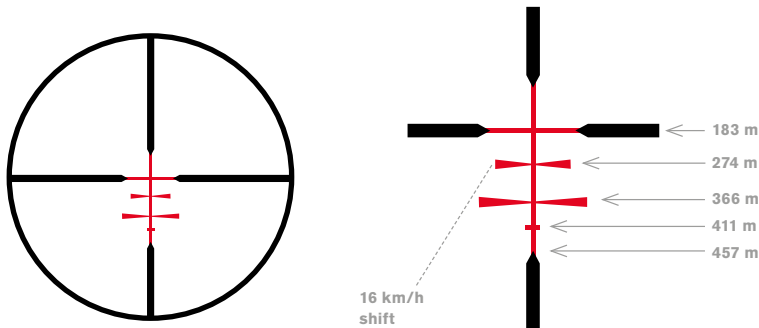

RANGE	POWER SELECTOR VALUES		16 KM/H DRIFT
	LARGE ▼ BULLET DROP	SMALL ▼ BULLET DROP	
183 m MOA	—	—	—
183 m mm	—	—	—
274 m MOA	2,19	2,74	2,16
274 m mm	175	219	172
366 m MOA	4,80	6,00	3,03
366 m mm	511	638	322
411 m MOA	6,26	7,83	—
411 m mm	749	936	—
457 m MOA	7,82	9,78	—
457 m mm	1040	1300	—

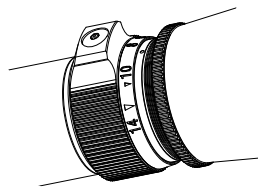

Duplex aiming point with CPC-style hold points.
Power Selector ballistics tuning.

ILLUMINATED LR VARMINT HUNTER

This fine-lined German 4-style central aiming point with cross-wire hold points is ideal for small targets at long range.

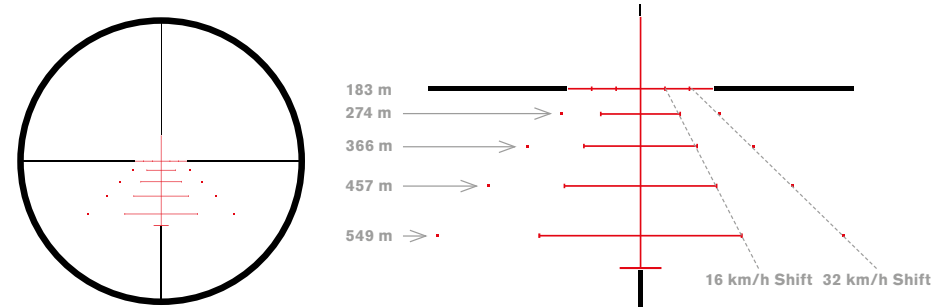

Reticle Feature Hold Point (Distance from Center)	MOA with Large Triangle (Max Magnification)	MOA with Small Triangle
274 m	1,81	2,26
366 m	4,13	5,16
457 m	7,02	8,78
549 m	10,63	13,3

Note: When using a cartridge in Group C (see "Power Selector Setting" section) and sighting-in at 274 meters, add 183 meters to all of the above hold points.

CREEDMOOR®

The Creedmoor® reticle enables the shooter to confidently make effective shots on big game animals out to 457 meters. The holdover values below are for standard loads between 89 cm and 114 cm of drop at 457 meters, with a 183 meter zero.

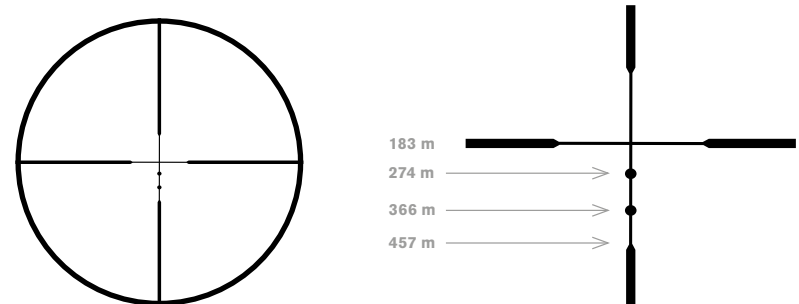

Reticle Feature Hold Point (Distance from Center)	MOA at High Magnification	MOA at Low Magnification
274 m	2,19	5,77
366 m	4,80	12,66
457 m	7,82	20,62

Note: Determine the appropriate ballistics group based on your cartridge. This will determine the distance at which you will need to zero the rifle.

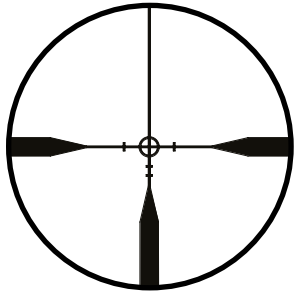

PIG-PLEX®

Taking down hogs on the move isn't easy, so we've simplified this design with aggressive, tapered posts for quick target acquisition and holdover points out to 457 meters. The bracketing features are specifically for measuring pigs.

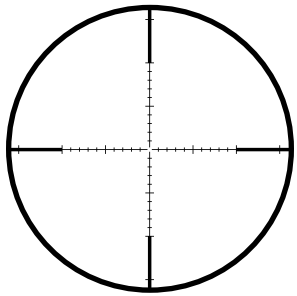
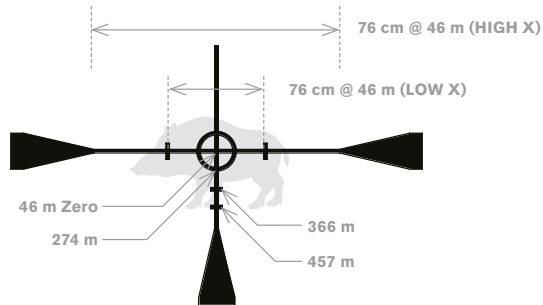

TMOA®*

Features 1-MOA stadia lines on the horizontal and vertical crosshairs for quick bullet drop and windage correction. The crosshair is left open to create a small clear aperture for increased precision at longer ranges. TMOA can also be used to range objects of known size.

*Available in illuminated and non-illuminated.

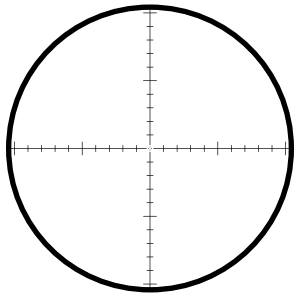

TMOA PLUS

Similar in design to the TMOA reticle, we added a fine plus point to the open center of the TMOA Plus for long-range aiming precision. Available on VX-6 7-42x56 only.

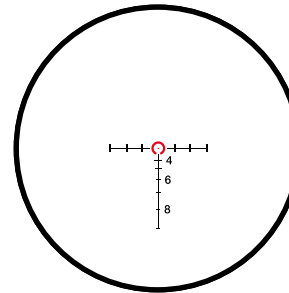
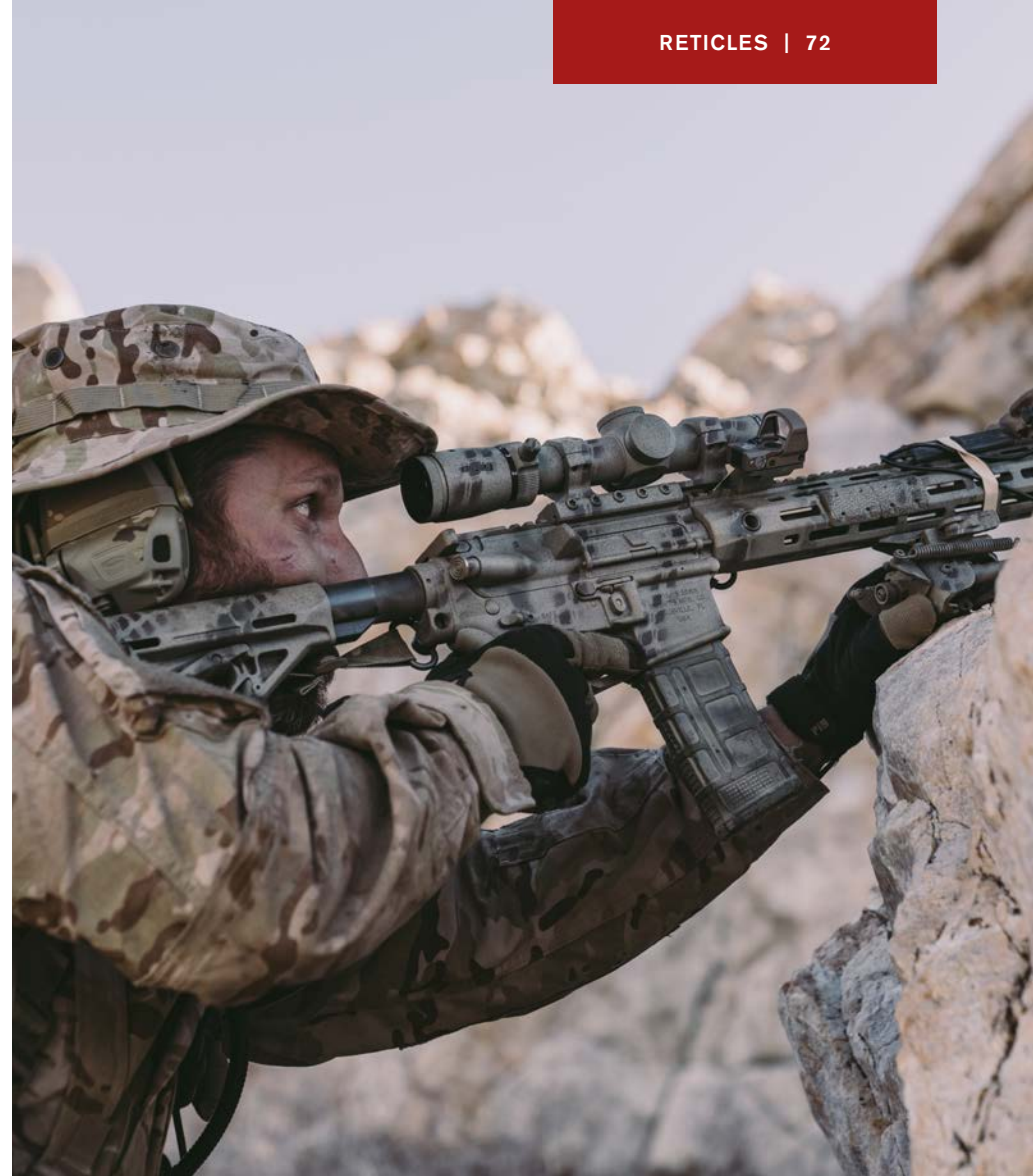

ILLUMINATED CM-R²™

The CM-R² provides the flexibility needed on modern-day battlefields. It combines the ranging ability of the Special Purpose reticle with the quick acquisition of the Circle Dot reticle to give you the edge on your target. Available on Patrol 6HD 1-6x24 CDS-ZL2 only.

ILLUMINATED FIREDOT® TACTICAL MILLING RETICLE

Expanding on the traditional MIL Dot, it features various sized hash marks spaced at 0.5-MIL increments along the vertical and horizontal stadia for increased ranging precision and accuracy. The daylight-visible red illuminated FireDot® in the center of reticle aids with target acquisition and shot placement.

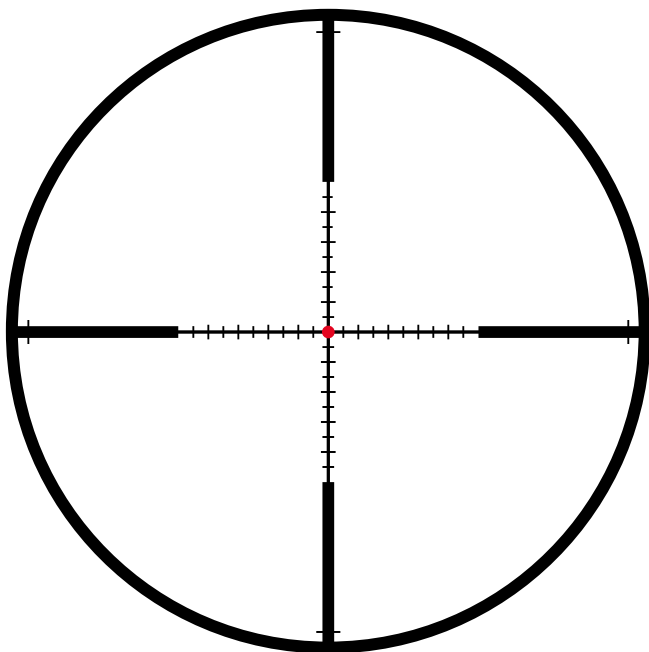

ILLUMINATED FIREDOT SPECIAL PURPOSE RETICLE

Provides greater precision at longer ranges than is generally possible with other reticle styles, yet it also excels in close-range, low-magnification engagements. The daylight-visible red illuminated FireDot aids in target acquisition and shot placement.

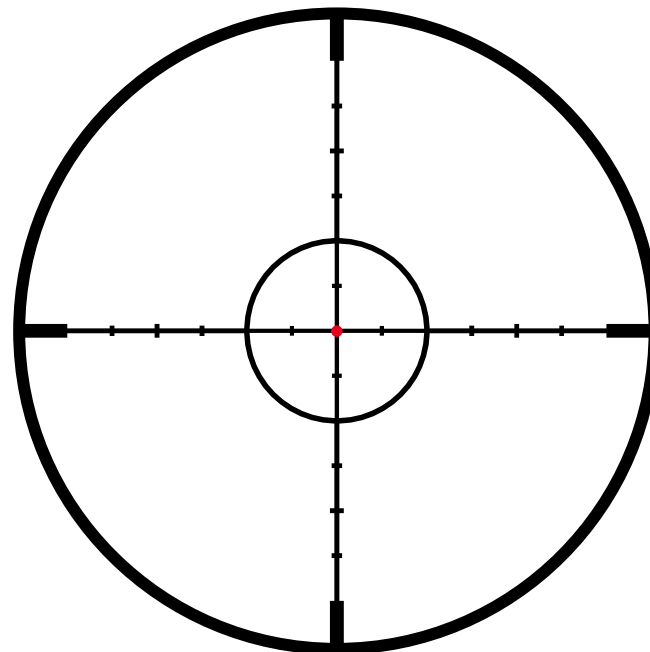

ILLUMINATED FIREDOT BDC

Designed with input from top 3-Gun shooters, the Illuminated FireDot BDC reticle provides a daylight-visible illuminated center dot for rapid target acquisition in any lighting conditions. Bullet drop compensation out to 549 meters, matching most popular bullet weights for 3-Gun competition, provides accurate holdovers and compensation for 8 km/h wind drift out to 457 meters.

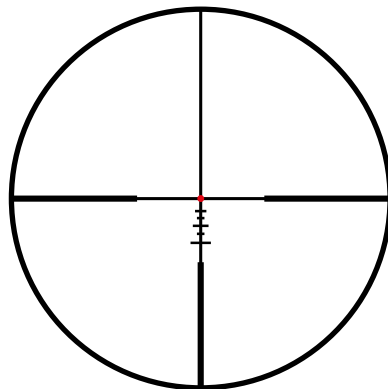

ILLUM. FIREDOT BDC (meters at 100 meters)	1x	3x	6x
274 m MOA	16,43	5,48	2,74
320 m MOA	25,60	8,53	4,27
366 m MOA	35,72	11,91	5,95
411 m MOA	46,23	15,41	7,7
457 m MOA	58,07	19,36	9,68
549 m MOA	83,48	27,83	13,91

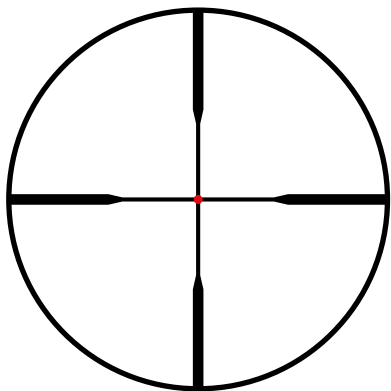

ILLUMINATED FIREDOT DUPLEX®

Takes the legendary Leupold-designed Duplex® reticle and adds an extra-bright center-point dot for quick target acquisition. Great for a broad range of game applications.

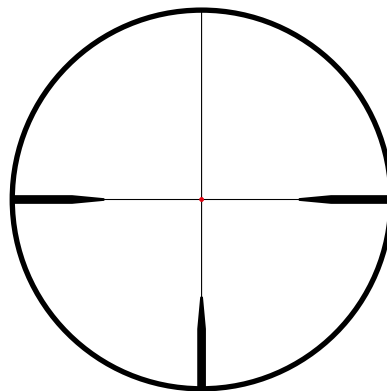

ILLUMINATED FIREDOT TWILIGHT HUNTER

Designed to help you see your aiming point even in the most challenging conditions, the Illuminated FireDot Twilight Hunter reticle makes it easier to ensure your point of aim is where it's supposed to be when light is at its lowest.

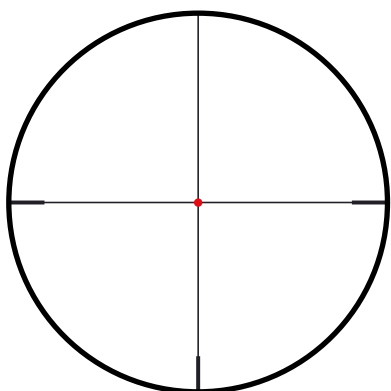

ILLUMINATED FIREDOT 4 FINE

This European-influenced design keeps the upper field free of obstructions, while the fine outer posts and fiber optic powered red dot center your target. Choose from multiple brightness settings to match the conditions. Includes Leupold's Motion Sensor Technology to conserve battery life.

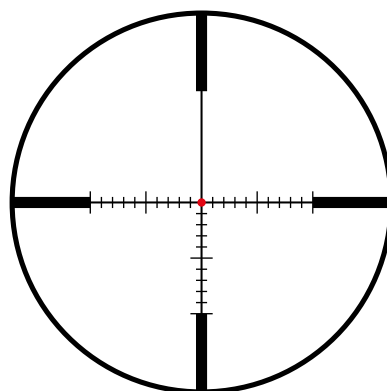

ILLUMINATED FIREDOT TRI-MOA

This proprietary Leupold® design is based on the T-MOA® reticle with hash marks in 1 MOA increments. It features 10 MOA of measurement in each direction of the lower half while the upper half is left open for observation and spotting. FireDot® Technology brings your eye to the center of the reticle for quick target acquisition.

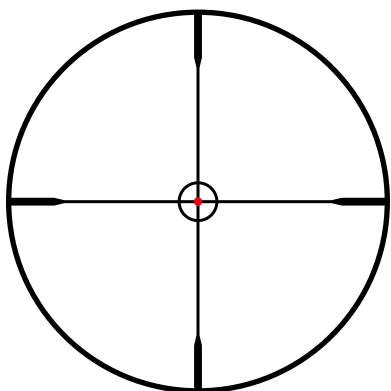

ILLUMINATED FIREDOT BULL-RING

The Bull-Ring circles standard NRA Service Rifle targets and features a hollow center ring that adjusts with magnification. The fiber-optic powered red dot brings your eye to the center of the reticle for quick target acquisition. Multiple brightness settings allow the shooter to adjust for changing conditions.

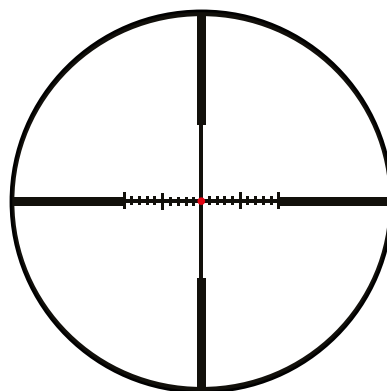

ILLUMINATED FIREDOT WIND-PLEX

The FireDot Wind-Plex can be used with any caliber round and is best utilized with our Custom Dial System® (CDS®). Wind holds at 1 MOA increments on each side are designed to help compensate for crosswinds. Includes Leupold's Motion Sensor Technology to conserve battery life.

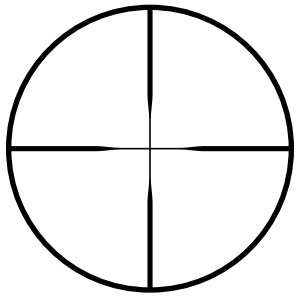

DUPLEX

Designed by Leupold in 1962, the Duplex is defined by its heavy posts — which stand out against cover and in twilight conditions — and a thin crosshair that maintains a clear view in the center.

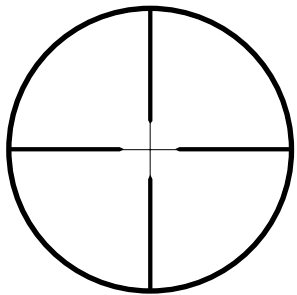

FINE DUPLEX

The Fine Duplex has thinner posts and crosshairs, which allow for less target coverage, making precision shots on small targets easy.

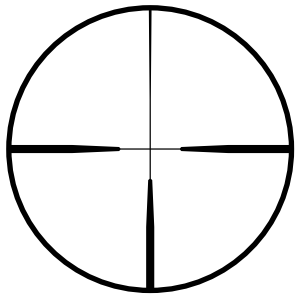

HUNT-PLEX

Designed with the hunter in mind, the Hunt-Plex reticle allows for precise shot placement in some of the toughest lighting conditions. The bold, tapered pickets draw in toward the center allowing for fast target acquisition when low-light conditions wash out the fine lines of your reticle.

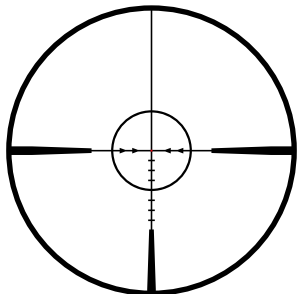

MOA-RING

Designed for aiming at fast moving, close targets. Lead markers on the horizontal line indicate 10 mph (16 km/h) and 20 mph (32 km/h) speed. Arrows indicate the direction of movement.

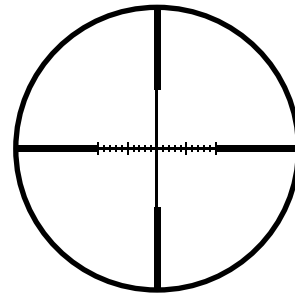

WIND-PLEX®

This reticle takes the versatility of the Duplex reticle and adds wind hold marks at 1 MOA increments on the windage plane for simple corrections. It also works with the Leupold Custom Dial System to provide a complete ballistic correction solution.

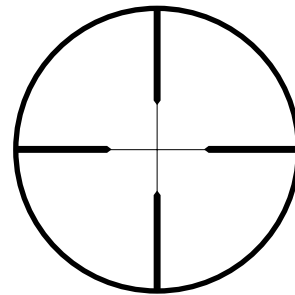

WIDE DUPLEX

Leupold designed the Wide Duplex reticle with a larger center gate for lightning-fast target acquisition, even on a moving target.

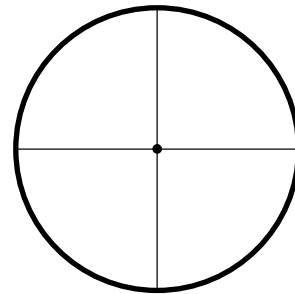

1/8 MOA TARGET DOT

This is a conventional shooter's dot, which seems to "float." The crosshairs are extremely thin.

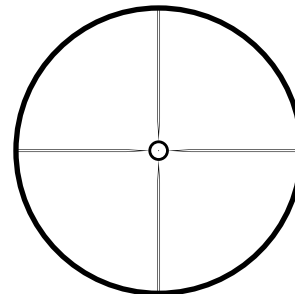

HPR-1

Specifically designed for CMP competition. Tapered posts draw the eye to center while the 0.5 MOA dot provides definitive aiming point. 8 MOA inner diameter of circle provides easy bracketing of targets.



HORUS® RETICLES

The Horus® Reticle System is an optically precise reticle that has a uniform grid etched on the glass of the front focal plane. The reticle features a built-in rangefinder on the bottom half to provide a clear picture and numeric information about the target.

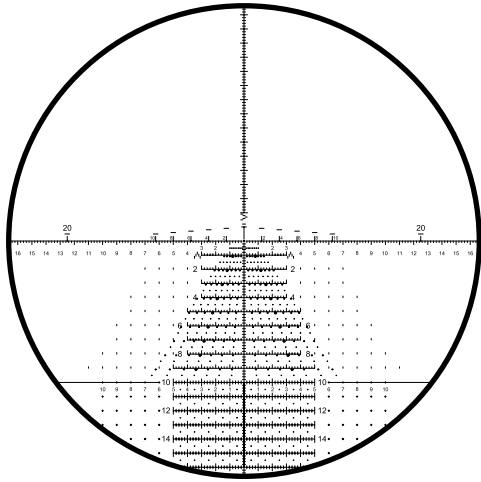

TReMoR3®

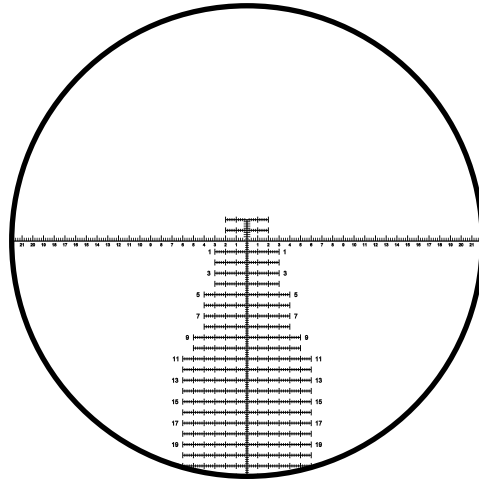

H59®

MIL DOT*

Dots are spaced in 1-MIL increments on the crosshair. Using the MIL formula, shooters can create a table based on the known size of the object targeted. Bracket the object between dots and refer to the table for an estimated distance to the target.

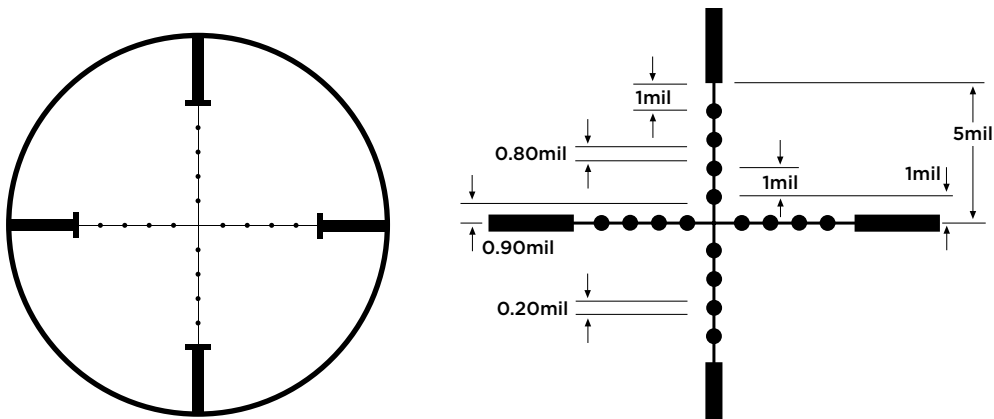

ILLUMINATED TACTICAL MILLING RETICLE® (TMR®)*

The Tactical Milling Reticle uses various sized and spaced hash marks on the vertical and horizontal stadia for increased ranging precision and quick one-meter range estimating reference points. To use the system, simply determine the range to the target using the MIL system, then use the corresponding aiming point that is matched to your cartridge to engage the target.

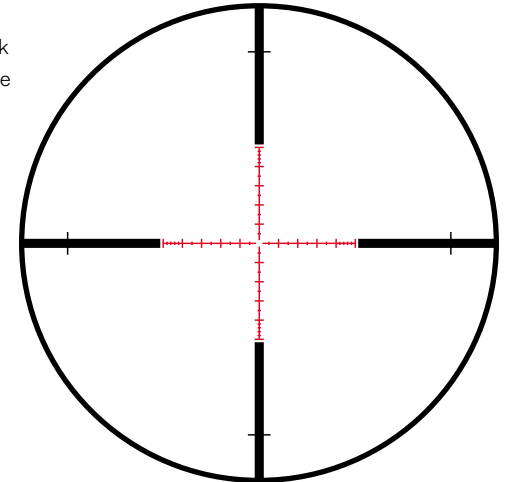

DETAIL 1

0.40 MIL → | ←

0.15 MIL → | ←

FINE LINES ARE

- 0.06 MIL @ 8x
- 0.05 MIL @ 10x
- 0.04 MIL @ 14x
- 0.03 MIL @ 16x, 20x & 40x
- 0.02 MIL @ 25x

DETAIL 2

5.00 MIL

1.00 MIL

1 METER TARGET RANGING

- 500.0 METERS →
- 555.6 METERS →
- 625.0 METERS →
- 714.3 METERS →
- 833.3 METERS →
- 1000.0 METERS →

CENTER APERTURE IS

- 0.18 x 0.18 MIL @ 8x
- 0.14 x 0.14 MIL @ 10x
- 0.10 x 0.10 MIL @ 14x & 40x
- 0.09 x 0.09 MIL @ 16x
- 0.07 x 0.07 MIL @ 20x
- 0.06 x 0.06 MIL @ 25x



DUPLIX STYLE RETICLE SUBTENSIONS				
Scope Type		FX-3	FX-I Rimfire	
Scope Model		6	4 RF	
Power Setting		6	4	
Fine Duplex	Heavy Section	inch	-	1.4
		cm	-	3.9
	Thin Section	inch	-	0.4
		cm	-	1.1
	Thin Opening	inch	-	17.3
		cm	-	48.1
Duplex	Heavy Section	inch	1.5	-
		cm	4.1	-
	Thin Section	inch	0.5	-
		cm	1.4	-
	Thin Opening	inch	23.3	-
		cm	64.6	-

ULTRALIGHT RETICLE SUBTENSIONS			
Scope Type		Ultralight	
Scope Model		2.5	
Power Setting		2.5	
Wide Duplex	Heavy Section	inch	4.1
		cm	10.5
	Thin Section	inch	1.3
		cm	3.9
	Thin Opening	inch	32.2
		cm	81.8

HANDGUN RETICLE SUBTENSIONS					
Scope Type		Handgun			
Scope Model		4	2.5-8		
Power Setting		4	2.5	8	
Duplex	Heavy Section	inch	1.6	2.4	0.8
		cm	4.4	6.7	2.2
	Thin Section	inch	0.5	0.8	0.3
		cm	1.4	2.2	0.8
	Thin Opening	inch	10.5	15.7	5.3
		cm	29.2	43.6	14.7

COMPETITION RETICLE SUBTENSIONS			
Scope Type		Competition	
Scope Model		45	
Power Setting		45	
1/8 Target Dot	Dot	inch	0.12
		cm	0.30
	Thin Section	inch	0.01
		cm	0.03

LEUPOLD, GOLD RING, the Golden Ring design, the Circle-L reticle logo design, the Gold Ring Box and various other marks are registered trademarks of Leupold & Stevens, Inc. All marks, including corporate logos and emblems, are subject to Leupold's rights and may not be used in connection with any product or service that is not Leupold's, or in any manner that disparages or discredits Leupold, or in a manner likely to cause confusion.

Certain other trademarks used in connection with Leupold products and services are the property of their respective owners, and are used with permission.

The ARD (anti-reflection device) is manufactured by Tenebraex a Division of Armament Technology Incorporated 110 Chain Lake Drive Unit 3E, Halifax NS Canada B3S 1A9. THE BOONE & CROCKETT CLUB® and BOONE & CROCKETT® are registered trademarks of the Boone & Crockett Club. Horus® and Horus Vision® are registered trademarks of HVRT Corp. Mossy Oak® Original Bottomland®, Mossy Oak®, are trademarks or registered trademarks of HAAS Outdoors, Inc. RMEF® and ROCKY MOUNTAIN ELK FOUNDATION® are registered trademarks of the Rocky Mountain Elk Foundation, Inc. Ruger® is a registered trademark of Sturm, Ruger & Company, Inc. Torx® is a registered trademark of Acument Intellectual Properties, LLC.

We reserve the right to make design and/or material modifications without prior notice.

For patent information, visit leupold.com/patents

Copyright © 2023 Leupold & Stevens, Inc. All rights reserved.

Leupold products are manufactured under one or more of the following patents:

U.S. Patents 6,295,754; 6,351,907; 6,359,418; 6,469,829; 6,519,890; 6,691,447; 6,816,305; 7,088,506; 7,177,087; 7,185,455; 7,275,343; 7,375,581; 7,603,804; 7,646,535; 7,654,029; 7,684,114; 7,690,145; 7,706,065;

7,721,480; 7,738,082; 7,827,723; 7,908,083; 7,934,335; 7,944,611; 8,006,429; 8,046,951; 8,049,959; 8,091,268; 8,286,384; 8,314,923; 8,448,372; 8,516,736; 8,619,238; 8,705,173; 8,780,333; 8,806,798; 8,915,392; 8,959,823; 9,038,307; 9,046,913; 9,115,958; 9,170,068; 9,182,773; 9,188,408;

9,291,808; 9,292,034; 9,423,212; 9,429,745; 9,435,610; 9,453,706; 9,482,488; 9,568,277; 9,574,852; 9,593,907; and 9,665,120. D490,097; D506,520; D512,449; D517,153; D519,537; D532,477; D532,803; D536,762; D542,879; D562,428; D566,309; D579,471; D580,509; D583,898; D584,376; D587,333; D589,544; D589,581; D590,970; D594,495; D611,973; D613,322; D671,974; D672,381; D674,831; D675,239; D676,096; D682,339; D684,653; D685,831; D685,832; D703,784; D704,295; D709,588; D730,477; D733,248; D733,832; D753,785; D771,171 and D790,654.

Foreign Patents: AT14606; AT13697; AT E 693863; AT E 755572; AT2033037; AU2012271904; AU362628; AU362629; AU362630; AU362860; CA162761; CA162789; CA162839; CA2801641; CNZL200680040794.8; CNZL200710166859.X; CZ2033037; DE202014000102.2; DE202005017276; DE2033037; DE212013000042.1; DE2778738; DE602014000325.7; DE49903766.9; DEM9304093.8; EM000059613-0001; EM000059613-0002; EM000059613-0003; EM000059613-0004; EM000393467-0001; EM000393467-0002; EM000393467-0003;

371033-0002; EM002017707-0001; EM002081281-0001; EM002081281-0002; EM002714949-0001; EM002714949-0002; EM002714949-0003; 0631; RO2033037; SE55201; TWI464361; TWI429875; ZA2003/8164; and ZA2013/0252.

RETICLES BY MODEL

Choose a riflescope to see what reticles are available for that model, or choose a reticle to see what riflescopes it's available in. For the most up-to-date information, visit Leupold.com.

Reticles	VX-6HD	VX-5HD	VX-3HD	VX-Freedom	Competition	FX	Handgun	Patrol 6HD	Mark 5HD	Mark 3HD	DeltaPoint Pro	DeltaPoint Micro	Freedom RDS
Duplex		X	X	X			X						
Fine Duplex			X	X		X							
Wide Duplex						X							
Wind-Plex		X	X										
1/8 Min. Target Dot					X								
Hunt-Plex				X									
HTMR		X											
Illuminated FireDot Duplex	X	X					X						
Illuminated FireDot 4 Fine	X	X											
Illuminated FireDot Twilight Hunter			X	X									
Illuminated FireDot Bull-Ring					X								
Tri-MOA	X			X									
Rimfire-MOA				X									
UltimateSlam				X									
Combat Competition Hunting (CCH)								X					
Boone and Crockett Big Game		X	X										
Illuminated Boone and Crockett Big Game	X												
Illuminated LR Varmint Hunter	X												
TMOA		X											
Illum. TMOA	X							X					
TMOA Plus					X			X					
Pig-Plex				X									
Creedmoor				X									
HPR-1					X								
Illuminated CM-R ²							X						

Reticles	VX-6HD	VX-5HD	VX-3HD	VX-Freedom	Competition	FX	Handgun	Patrol 6HD	Mark 5HD	Mark 3HD	DeltaPoint Pro	DeltaPoint Micro	Freedom RDS
MOA-Ring				X									
1 MOA Red Dot													X
2.5-MOA Red Dot											X		
3 MOA Red Dot												X	
6 MOA Red Dot											X		
PR1-MOA									X				
PR1-MIL									X				
Illuminated PR1-MIL									X				
PR2-MOA									X				
PR2-MIL									X				
AR-Ballistic										X			
Illuminated FireDot BDC										X			
Illuminated FireDot SPR										X			
Illuminated FireDot TMR										X			
Tremor3 [®]									X				
Illuminated Tremor3 [®]									X				
H59									X				
Mil Dot										X			
Tactical Milling Reticle (TMR)									X				
Illuminated Tactical Milling Reticle (TMR)									X				

DEFENDING WILDLIFE THROUGH CONSERVATION

The future of hunting is in all of our hands, and while we have a right to enjoy wildlife and wild places, it's our responsibility to protect it. That is why Leupold stands with and financially supports so many organizations whose mission is to conserve wildlife, as well as protect, enhance, and grow the habitat it depends on.

LEUPOLD INFLUENCERS WHO HAVE PROVIDED PHOTOS FOR THIS CATALOG INCLUDE:

Andreas Barth @dreispross

Björn Bleiß @bjoern_bleiss

Cervus UK @cervusuk

Farming the Wild @farmingthewild

Irene Christiansen @jaktjenter

JE Wilds @j.e.wilds

Kristoffer Clausen @kristofferclausen

Marijan Loch @marijan_aa1shooting

Mathias Nedergård @mathias.nn_shooting

Mike Robinson @mikerobinsonchef

Pedro Ampuero @pedroampueroaca

Rihana Cary @rihanacary

LEUPOLD IS HERE TO HELP

If your Leupold product fails to perform or isn't living up to your expectations in some way, we want to know, because we want to make it right. Often, by contacting one of our Product Service Specialists, you can resolve the problem without ever sending the product back to Leupold. If you do need to return your Leupold product for service, follow the steps at Leupold.com/service-support/services-repair.

FOR QUESTIONS, ADVICE ON A PRODUCT, OR REPLACEMENT PARTS

Leupold's Product Service Specialists are here to answer any questions you may have about product recommendations, operation, or any other technical issues. We can even help you with spare parts.

Contact us in writing (to the U.S. Mail address below,

Attn: Technical Service Department), by phone, fax, or email.

Phone: +1 (503) 526-1400 • **Fax:** +1 (503)352-7621 • **Email:** productspecialist@leupold.com

GET LEUPOLD'S LATEST CATALOG

You can download Leupold's latest catalog directly at Leupold.com.

FIND YOUR NEAREST LEUPOLD DEALER

Use Leupold's Dealer Locator at Leupold.com.

TO REACH LEUPOLD PRODUCT SERVICE

Parcel Service

Leupold & Stevens, Inc.
Attn: Product Service Department
14400 N.W. Greenbrier Parkway
Beaverton, OR 97006-5790 U.S.A.

Leupold Customers in Europe

For any service inquiries please contact your local Leupold dealer, where you purchased your Leupold product from.

U.S. Mail

Leupold & Stevens, Inc.
Attn: Product Service Department
PO Box 688
Beaverton, OR 97075-0688 U.S.A.
Phone: 8:00 am - 4:30 pm PST M-F
+1 (503) 526-1400

Fax: 24 hours a day, 7 days a week
+1 (503) 526-1400

E-mail: productspecialist@leupold.com

VISIT LEUPOLD.COM

Here, you'll be able to learn more about our legendary riflescopes, from how they're made to how they're tested. You'll find extensive information about all our other products, as well. Use the Leupold Scope Finder, Reticle Finder, and Mount Finder to get the perfect setup for your needs.



Find us on social media everywhere at leupoldoptics



 **LEUPOLD.** | *BE RELENTLESS*