



HERPORE

PRODUCT CATALOG 2026 ENGLISH 

RIFLESCOPES AND SIGHTS

TECHNOLOGY	2-5
VX-6HD GEN 2	8
NEW VX-5HD GEN 2	10
NEW VX-4HD	11
VX-3HD	13
VX-FREEDOM	14
FREEDOM RDS	15
MARK 5HD	18
MARK 4HD	20
NEW PATROL 6HD GEN 2	21
DELTAPOINT PRO	22
RIFLESCOPE DETAILED MEASUREMENTS ..	24

BINOCULARS

BX-5 SANTIAM HD	28
BX-4 RANGE HD TBR/W GEN 2	29
BX-4 PRO GUIDE HD GEN 2	30
BX-2 ALPINE HD	31
BX-1 MCKENZIE HD	32
BX-1 ROGUE	33
SPOTTING SCOPES	
SX-5 SANTIAM HD	36
SX-4 PRO GUIDE HD GEN 2	38
SX-2 ALPINE HD GEN 2	39
MARK 4 TACTICAL	40

RANGEFINDERS

RANGEFINDER TECHNOLOGY	43
RX-5000 TBR/W	44
BX-4 RANGE HD TBR/W GEN 2	45
RX-1400i TBR/W	46
RX-FULLDRAW 5	47
NEW PERFORMANCE EYEWEAR	48-53
LEUPOLD PRO GEAR	56-59
NEW MOUNTS	60-63
RETICLES	64-71
RETICLES BY MODEL	72
PRODUCT SERVICE INFORMATION	73





RELENTLESS INNOVATION UNMATCHED CONFIDENCE:

We don't build products to keep pace; we build them to set the standard. For over a century, we've refused to compromise on performance, durability, or the trust our customers place in our name. That same drive fuels every engineer, designer, and craftsman who carries our promise forward today.

Innovation isn't about adding new features, it's about solving real problems for the people who rely on us when there's no room for doubt. It's why we continue to pioneer products that deliver more clarity, more precision, and more confidence when everything is on the line. This year, that relentless pursuit reaches new heights with the BX-6 Range HD—proof that when cutting-edge technology meets uncompromising clarity, there are no limits to what's possible.

But it's not just about what we make, it's about who we make it for: the hunters, shooters, and competitors who refuse to settle for second best. Every time you shoulder a rifle, glass a ridgeline, or step onto the range, we're right there with you. Because like you, we know success isn't luck—it's earned through preparation, confidence, and the will to outwork everything standing in your way.

For those who never quit, **BE RELENTLESS.**

BRUCE PETTET,
PRESIDENT & CEO, LEUPOLD & STEVENS, INC.



LEUPOLD LIFETIME GUARANTEE. WE GUARANTEE PERFORMANCE, OTHERS WARRANTY FAILURE.

If your Leupold riflescope, red dot sight, binocular, or spotting scope doesn't perform, we will repair or replace it for free - whether you're the original owner or not. You don't need proof of ownership or a warranty card, and there's no time limit. We do this because we believe in superior quality and craftsmanship, and we're confident your Leupold won't let you down.

We can do this because we use superior craftsmanship to create superior optics, and we're confident your Leupold won't let you down at a crucial moment. That's the power of our company: we stand behind our work.

Please contact your LEUPOLD dealer.

RELENTLESS INNOVATION

Always innovating. Relentless performance requires constantly pushing ourselves and our products to their limits. Finding out what works, what doesn't, and what you need to be successful in the field. Leupold was born from the idea that we can do it better than anyone else, which still holds true today. Our elite team of almost 100 engineers share one goal—build products that are guaranteed to perform for life.

CUSTOM DIAL SYSTEM® (CDS®)

CDS simplifies longer shots by eliminating the need for holdovers or ballistic calculations, using a custom dial that's specific to your rifle and ammo.

FAST-FOCUS EYEPIECE

Our fast-focus eyepiece quickly brings your reticle into focus with minimal adjustments. Twist the eyepiece until you get a crisp view of your reticle and then you're good to go.

FORM-FIT EYECUPS

Upgrade your viewing experience with Form-Fit Eyecups. These interchangeable designs include a winged eyecup to eliminate stray light, a medium eyecup for standard use, and a low eyecup that maximizes your field of view when wearing glasses.

GUARD-ION™ HYDROPHOBIC LENS COATING

Our proprietary lens coating sheds water, dirt, oils, and more keeping your lenses clean and clear.

SCRATCH RESISTANT LENSES

Provides added lens durability.

MOTION SENSOR TECHNOLOGY (MST™)

Always be ready to go with motion activated reticle illumination. It extends battery life by shutting off illuminated reticles after five minutes of inactivity and instantly turns on when moved.

SPEEDSET™ DIAL

The SpeedSet dial trims seconds off your setup time. Its tool-free design allows you to adjust your zero using just your hands—no need to worry about forgetting a wrench. Simply make your adjustments, flip the switch, align your zero, and lock it in. Once secured, the dial stays tight until you decide to change it.

TRUE BALLISTIC RANGE/WIND (TBR/W)

Leupold rangefinders with TBR/W technology take into account the angles of your shots and your rifle's ballistics to calculate deadly accurate shoot-to distances out to 732 meters. Other rangefinders can't deliver accurate ranges because they only use trigonometry to generate straight-line horizontal distances (Rifleman's Rule). Additionally, TBR/W provides a 10-mph wind-

hold value (90° angle). When combined with a Leupold CDS scope and a reticle with wind-hold capability, TBR/W allows you to quickly get on target at any distance and in any wind condition.

ARCHER'S ADVANTAGE™ SOFTWARE

Select Leupold RX rangefinders now offer custom ballistic solutions using Archer's Advantage™ software. Using your arrow weight, arrow velocity, and peep height, Archer's Advantage™ software calculates extremely accurate ballistic solutions for high-angle short-distance shots, and medium-angle long-distance shots.

FLIGHTPATH™ TECHNOLOGY

Leupold RX rangefinders with Flightpath technology make it easy to determine if your arrow will clear obstructions between you and the target out to a typical distance of 78 meters. An illuminated mark in the display indicates the highest point of your arrow's trajectory so you can take tight shots with total confidence.

NIGHT VISION

Leupold Riflescopes are night vision compatible when used with IR or thermal clip-on device.

LEUPOLD CONTROL APP

Leupold's Bluetooth-enabled rangefinders seamlessly link with the Leupold Control app, allowing you to easily adjust settings, choose personalized display options, and accurately range targets with just a few quick taps on your mobile device. (The global introduction of the App is an evolving process.)



App available for iOS & Android

PINNING

Deliver location pinning directly to your smartphone using the Leupold Control app and popular maps like onX Hunt, Apple Maps, and Google Maps. Mark unlimited waypoints to outline your approach for your next stalk, pinpoint your game's exact location, or set up a course of fire on the range.

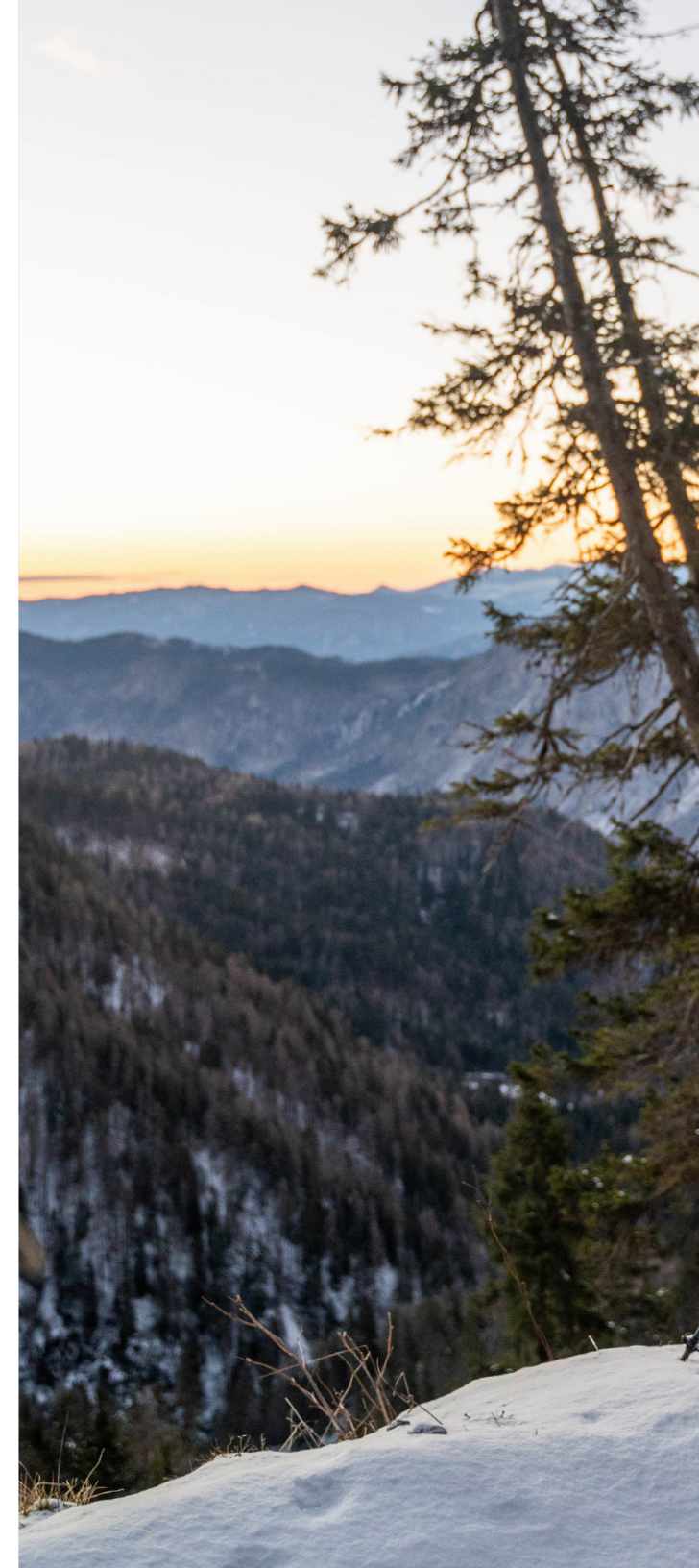

LEUPOLD OPTICAL SYSTEMS

DELIVERING INDUSTRY-LEADING BRIGHTNESS AND CLARITY

Each Leupold Optical System builds off of the previous one to ensure every Leupold product has the clearest, brightest image in its class.

The Advanced Optical System has stood the test of time and outperforms most optics on the market, while the Elite Optical System delivers even more performance for those diehard hardcore hunters and shooters who demand as much from their optics as they do from themselves. The Professional-Grade Optical System delivers unmatched performance for professional guides and shooters who require the brightest, clearest optics on the market, no matter the conditions.

WHICH OPTICAL SYSTEM IS RIGHT FOR YOU?

ADVANCED OPTICAL SYSTEM

Leupold's Advanced Optical System offers tried and true light transmission for extended glassing sessions, best in class glare reduction in harsh light, and the resolution and clarity that recreational sportsmen and sportswomen demand.

ELITE OPTICAL SYSTEM

Leupold's Elite Optical System offers excellent dawn-to-dusk light transmission for a bright image when it matters most, elite-level glare reduction in harsh light, and the resolution and clarity that diehard hunters and shooters demand.

PROFESSIONAL-GRADE OPTICAL SYSTEM

Leupold's Professional-Grade Optical System offers unmatched light transmission that's designed to outperform in the most challenging lighting conditions, industry-leading glare reduction for a clear image in harsh, direct light, and the resolution and clarity that professional guides and shooters demand in the field.



LEUPOLD'S CUSTOM DIAL SYSTEM



RANGE IT

If the target is 400 meters away

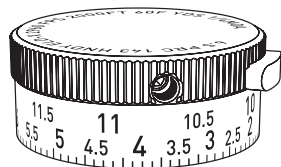

DIAL IT

Turn the dial to 4



AIM DEAD ON

No more worrying about holdovers

FIRST-SHOT ACCURACY

The Custom Dial System (CDS) makes accurate long-range shooting this simple: range your target, turn your CDS dial to match the range, aim dead on, then squeeze the trigger. With a CDS dial and some practice, you can shoot farther and more accurately than ever before.

Here's how it works: we customize your scope's elevation dial to match your exact load, velocity, and even the average atmospheric conditions where you hunt for unprecedented precision. With your CDS dial, you'll easily compensate for bullet drop and make ultra-quick adjustments on the fly. You can even create multiple dials for the same riflescope to match different loads or different conditions.

Get TWO free CDS dials with the purchase of any VX-6HD Gen 2 riflescope.

Get ONE free CDS dial when you purchase any other CDS-ready riflescope.

OTHER CDS FEATURES INCLUDE:

- Instantly return to zero with the zero-stop
- Easily change dials for different loads; simply loosen the set screws and swap out the dials. Changing dials on the VX-6HD Gen 2 and VX-5HD Gen 2 riflescope is even easier and does not require a tool
- Precision click adjustments for accurate zeroing
- Permanently laser-engraved load information and range markings
- With CDS-ZeroLock® 2 (both CDS-ZL2 and CDS-SZL2) dials, you get two revolutions of elevation, quickly set your dial or return to zero with the push of a button, and eliminate accidental dial rotation



LEUPOLD DIAL GUIDE



FINGER CLICK ADJUSTMENTS WITH RESETTABLE ZERO INDICATOR

Low-profile covered dials. Fast, precise sight-in without coins or tools.



POP UP REZERO DIAL

Easily align the zero on the dial to the index mark on the housing by popping up, spinning, and snapping down the dial.



CDS DIALS

Low-profile, 1/4-MOA click adjustments. Can be laser engraved with your custom load information and range markings. No cover to lose. Your first CDS dial is engraved for free, when you purchase any CDS-ready rifle scope.



CDS ZEROLOCK DIAL

Low-profile, one revolution, CDS-ready dials. Push the lock release button to unlock it and dial, then simply rotate it back to zero to lock it back in place. Can be laser engraved with your custom load information.



CDS-ZL2 DIALS

Low-profile, two revolution, CDS-ready dials. The lock release button protrudes on the first revolution and is flush on the second. Can be laser engraved with your load information and range markings.



CDS-SZL2 DIAL

This low-profile, tool-free dial enables quick zero adjustments. To use it, simply flip the switch, make your changes, and lock it in place. The ZeroLock release button protrudes during the first revolution and sits flush during the second.



ZL WINDAGE DIALS

ZeroLock windage dial prevents unintended adjustments and ensures an accurate return to zero. Fast and easy to use.



SZL WINDAGE DIALS

Features the same tool-free design as our CDS-SZL2 elevation dial. Prevents unintended adjustments and ensures an accurate return to zero. Fast and easy to use.



M5C3 ZEROLOCK DIALS

Low-profile, three revolution dials. 0.1 MIL per click for 30 MILs of adjustment in 3 turns, at 10 MILs per turn. The ZeroLock feature prevents inadvertent adjustments and ensures accurate return to zero.



M1C3 ZEROLOCK DIALS

Low-profile, three revolution dials. 1/4-MOA per click for 75 MOA of adjustment in 3 turns, at 25 MOAs per turn. The ZeroLock feature prevents inadvertent adjustments and ensures accurate return to zero.



1/4-MOA CAPPED DIAL

Low-profile covered dials. Fast, precise sight-in without coins or tools. Allows access to the full range of your scope's elevation travel.

HUNTING DIALS							
Adjustment Type	Click Increment	Adjustment Per Revolution	Lock Type	Travel Limit	Rezero Type	2 Revolution Indicator	Custom Ballistic Lasering [CDS]
Finger Click	1/4-MOA	15 MOA	None	Scope Total Travel	Index Ring	None	No
Finger Click (Metric)	1 cm / 100 m (0.1 MIL)	60 cm / 100 m (6 MIL)	None	Scope Total Travel	Index Ring	None	No
CDS	1/4-MOA	15 MOA, 60 cm	None	Scope Total Travel, or 14-MOA with Zero Stop Custom Dial	Dial Slip	None	Yes
CDS-ZL	1/4-MOA	20 MOA	ZeroLock	18 MOA	Rear Facing Index Mark, Set Screw	None	Yes
CDS-ZL2	1/4-MOA	20 MOA	ZeroLock	38 MOA	Rear Facing Index Mark, Set Screw	Sinking Button	Yes
CDS-SZL2	1/4-MOA, 0.1 MIL*	20 MOA, 80 cm @100m	ZeroLock	38 MOA	Dial slip	Sinking Button	Yes

TACTICAL DIALS				
Elevation Adjustment Style	Elevation	Windage	Zero Stop/Revolutions	Travel/Revolution
Capped 1/4-MOA	1/4-MOA	1/4-MOA	No	25 MOA
M1C3 ZeroLock	1/4-MOA	1/4-MOA	Yes/3*	25 MOA
M5C3 ZeroLock	0.1-MIL	0.1-MIL	Yes/3*	10.5-MIL
CDS-ZL2	1/4-MOA	1/4-MOA	Yes/2	20 MOA
Pop Up Rezero	1/4-MOA	1/4-MOA	Yes/2	20 MOA

*30-MILs total with Tactile Revolution Indicator





VX-6HD GEN 2



Whether you're climbing rugged peaks in search of a ram or chasing bugling elk at last light—no matter the hunt, your path forward with the VX-6HD Gen 2 is one of total dominance. The Professional-Grade Optical System enhances your sight with unmatched clarity and brightness. Equipped with competition-grade precision adjustments and an integrated throw lever, this riflescope mirrors the high-performance aspects which define our Mark series. The innovative CDS-SZL2 dial eliminates the need for tools when zeroing or changing custom dials. No detail has been overlooked. This is the ultimate hunting riflescope.

VX-6HD Gen 2	RETICLE	Model #	Obj.	Maintube	Weight (grams)	Length (cm)	Eye Relief (mm)	FOV Low/High (m @ 100 m)	Elev. Adj. MOA
1-6x24 CDS-SZL2 SFP	A	183835	24mm	30mm	493	27,2	94 - 97	40,30 / 6,40	180
2-12x42 CDS-SZL2 SFP	A	183836	42mm	30mm	595	31,8	94 - 97	18,83 / 3,20	120
	A	184423							
3-18x44 CDS-SZL2 SFP SF	B	184424	44mm	30mm	627	34,3	94 - 97	12,77 / 2,13	85
	C	184425							
	A	183839							
3-18x50 CDS-SZL2 SFP SF	A	183839	50mm	30mm	666	34,3	94 - 97	12,77 / 2,13	85
3-18x56 CDS-SZL2 SFP SF	D	183840	56mm	30mm	700	34,3	94 - 97	12,77 / 2,13	85
4-24x52 CDS-SZL2 SFP SF	A	183841	52mm	34mm	743	36,8	94 - 97	9,37 / 1,60	100
4-24x52 CDS-SZL2 SFP SF	B	183843	52mm	34mm	743	36,8	94 - 97	9,37 / 1,60	100

SFP = Second Focal Plane. For more information, see page 65. SF = Side Focus. Weight includes Lens Covers, Throw Lever and Battery.

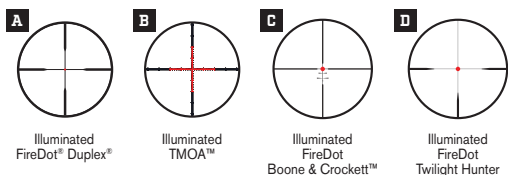

For more information and to see enlarged reticles, see pages 64-72.



All VX-6HD Gen 2 scopes are equipped with an Electronic Reticle Level.

When it's switched on, the illuminated reticle will blink if the VX-6HD Gen 2 is tilted more than one degree left or right. Bring it level, and the reticle will remain solid. This feature can aid in mounting the scope or using holdovers at long distances.

The leveling function can be switched on or off to suit your preference.

Get TWO free CDS dials with the purchase of any VX-6HD Gen 2 riflescope.





NEW

VX-5HD GEN 2

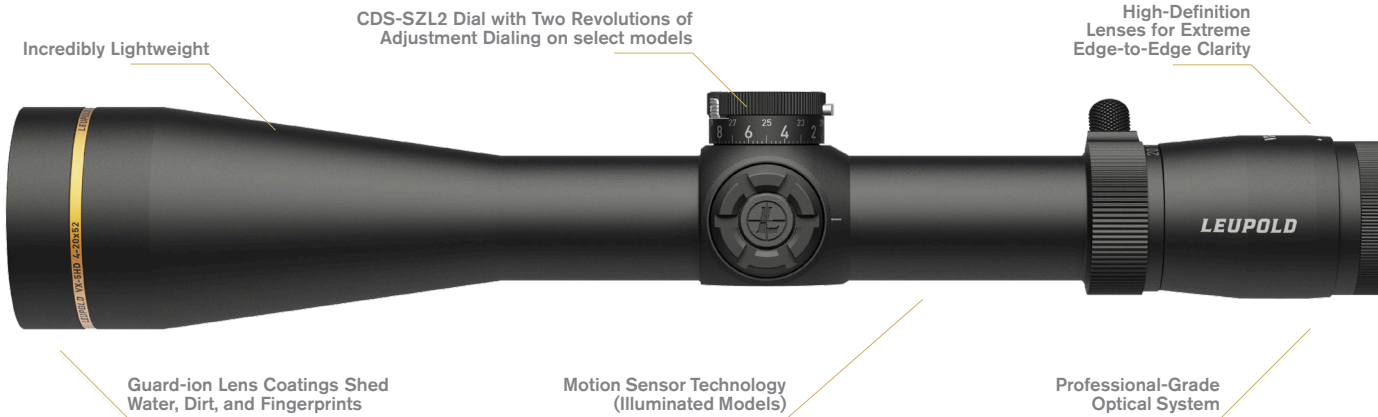

Incredibly Lightweight

CDS-SZL2 Dial with Two Revolutions of Adjustment Dialing on select models

High-Definition Lenses for Extreme Edge-to-Edge Clarity

Guard-ion Lens Coatings Shed Water, Dirt, and Fingerprints

Motion Sensor Technology (Illuminated Models)

Professional-Grade Optical System

It only takes one—one that does it all. When you're far from camp and seconds from your shot, you need a scope that'll never let you down. The VX-5HD Gen 2 features our Professional-Grade Optical System and delivers the absolute precision that serious hunters demand. With the CDS-SZL2 SpeedSet™ dial for quick, tool-free zeroing, an integrated throw lever, competition-grade adjustments and an ultra-rugged build, the VX-5HD Gen 2 is the ideal, everything-you-need optic. No other scope comes close. Not in precision, not in performance, not in value.

VX-5HD Gen 2	RETICLE	Model #	Obj.	Maintube	Weight (grams)	Length (cm)	Eye Relief (mm)	FOV (m @ 100 m)	Elev. Adj. MOA
1-5x24 Metric	C	183844	24mm	30mm	425	27,1	97 - 99	35,20 - 7,30	180
2-10x42 CDS-SZL2	B	183847	42mm	30mm	536	31,7	97 - 97	17,60 - 3,62	120
3-15x44 Side Focus CDS-SZL2	A	183848	44mm	30mm	564	34,2	97 - 99	11,52 - 2,43	85
	F	183849							
3-15x44 Side Focus CDS-SZL2	D	183851	44mm	30mm	567	34,2	97 - 99	11,52 - 2,43	85
	B	183850							
3-15x50 Side Focus CDS-SZL2	E	183854	50mm	30mm	604	34,2	97 - 99	11,52 - 2,37	85
3-15x56 Side Focus CDS-SZL2	G	183855	56mm	30mm	641	34,2	97 - 99	11,52 - 2,43	85
	C	183856-Metric							
4-20x52 Side Focus CDS-SZL2	A	183857	52mm	34mm	675	36,8	97 - 97	8,44 - 1,76	80
	B	183858							

All models are Second Focal Plane (SFP). For more information, see page 64. Gold = New Product

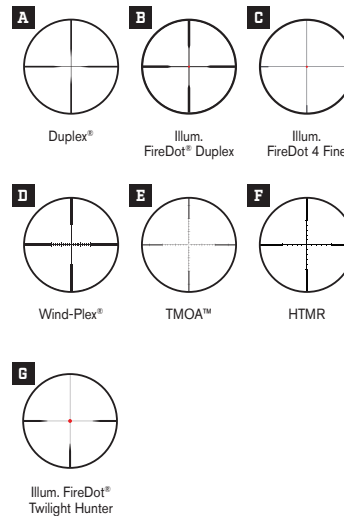

For more information and to see enlarged reticles, see pages 64-72.



NEW

VX-4HD



From tight timber to wide-open country, the VX®-4HD, with its true 4:1 zoom, is built to perform. Its Elite Optical System delivers a bright, crisp image when light gets scarce, and the integrated throw lever makes magnification changes fast and easy.

Built ultra-rugged to shrug off recoil and extreme weather, the VX-4HD gives you everything you need in one scope—performance, value, and durability that outworks and outperforms everything in its class.



CDS-ZL2 elevation dial available

VX-4HD	RETICLE	Model #	Obj.	Maintube	Weight (grams)	Length (cm)	Eye Relief (mm)	FOV (m @ 100 m)	Elev. Adj. MOA
3-12x40 Pop Up Rezero	B	185451	40mm	30mm	414	32,2	101,6 - 99	30,64 - 7,69	65
3-12x40 Side Focus CDS-ZL2	C	185453	40mm	30mm	442	32,2	101,6 - 99	30,64 - 7,69	90
3-12x50 Side Focus CDS-ZL2	A	185454	50mm	30mm	567	32,7	101,6 - 99	30,64 - 7,69	90
3-12x50 CDS-ZL2	C	185455	50mm	30mm	527	32,7	101,6 - 99	30,64 - 7,69	90
4-16x50 Side Focus CDS-ZL2	A	185456	50mm	30mm	581	33,7	101,6 - 99	22,95 - 5,77	65
	D	185458	50mm	30mm	589,6	33,7	101,6 - 99	22,95 - 5,77	65

All models are Second Focal Plane (SFP). For more information, see page 64. Gold = New Product

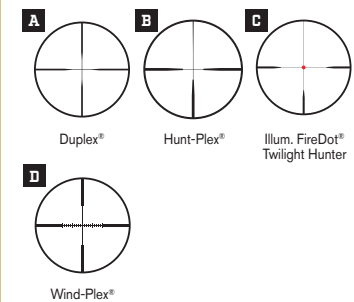

For more information and to see enlarged reticles, see pages 64-72



VX-3HD

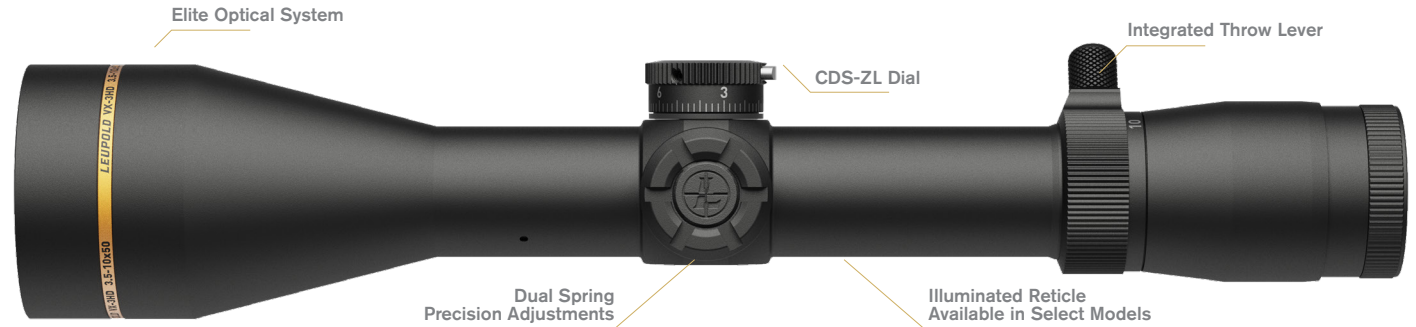

The VX®-3HD delivers what hunters want most in a riflescope: outstanding performance in low light, in an incredibly tough yet lightweight package. With Leupold's Elite Optical System, the VX-3 HD delivers excellent dawn-to-dusk light transmission for a bright image when it matters most, elite-level glare reduction in harsh light, and the resolution and clarity that diehard hunters and shooters demand. We also gave it match-grade repeatability and ergonomic controls that are easy to read and use, even with gloves. Models with illuminated reticles make the VX-3HD the best lightweight, low-light hunting scope in its class. And with its low-profile, one revolution CDS® ZeroLock® dial, you can be confident your dial will only move when you want it to. Push the button to unlock it, dial, and then rotate it back to zero to lock it in place. It's that simple. Everything we put into your VX-3HD is there to help you tag out.



All models feature CDS ZeroLock elevation dials

VX-3HD	RETICLE	Model #	Obj.	Maintube	Weight (grams)	Length (cm)	Eye Relief (mm)	FOV (m @ 100 m)	Elev. Adj. MOA		
1.5-5x20 CDS-ZL	B	180626	20mm	30mm	354	24,7	112 - 92	22,53 - 8,03	125		
2.5-8x36 CDS-ZL	A	180616	36mm	1 inch	334	29,0	112 - 92	12,50 - 4,57	70		
3.5-10x40 CDS-ZL	A	180617	40mm	1 inch	382	32,2	112 - 92	9,67 - 3,67	55		
3.5-10x40 CDS-ZL	B	180627	40mm	30mm	447	32,2	112 - 92	9,67 - 3,67	55		
3.5-10x50 CDS-ZL	A	180618	50mm	1 inch	428	31,2	112 - 92	9,90 - 3,67	55		
3.5-10x50 CDS-ZL	B	180628	50mm	30mm	498	31,2	112 - 92	9,90 - 3,67	95		
4.5-14x40 CDS-ZL	A	180619	D	180620	40mm	1 inch	379	32,2	112 - 92	6,63 - 2,47	75
4.5-14x40 CDS-ZL Burnt Bronze	C	180621	40mm	1 inch	379	32,2	112 - 92	6,63 - 2,47	75		
4.5-14x40 Side Focus CDS-ZL	C	180623	40mm	30mm	453	31,2	112 - 92	6,63 - 2,47	75		
4.5-14x50 CDS-ZL	A	180622	50mm	1 inch	479	31,2	112 - 92	6,83 - 2,53	75		

All models are Second Focal Plane (SFP). For more information, see page 64.

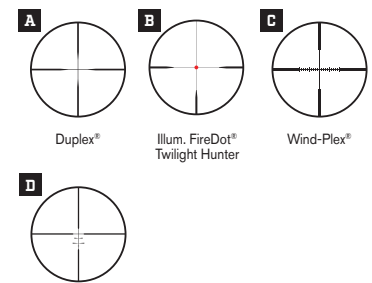

Boone and Crockett®

For more information and to see enlarged reticles, see pages 64-72.



VX-3HD 4.5-14x40 180621 Available in Burnt Bronze

VX-FREEDOM



The VX®-Freedom® delivers the legendary Leupold® performance and dependability hunters and shooters have demanded for decades. With the VX-Freedom you get best-in-class optics, unbeatable accuracy, and a wide variety of reticles. It's also everything you expect from a Leupold: designed, machined, and assembled in our Oregon factory, tested to the same ruggedness standards as our top-tier riflescopes, and covered by the Leupold Lifetime Guarantee.

VX-Freedom	RETICLE	Model #	Obj.	Maintube	Weight (grams)	Length (cm)	Eye Relief (mm)	FOV (m @ 100 m)	Elev. Adj. MOA
3-9x40	C	181307	40mm	1 inch	346	31,5	106-93	11,03 - 4,53	60
3-9x40 CDS	A	174182	40mm	1 inch	346	31,5	106-93	11,03 - 4,53	60
3-9x40 Rimfire	D	174181	40mm	1 inch	346	31,5	106-93	11,03 - 4,53	60
3-9x40 450 Bushmaster	A	176011	40mm	1 inch	346	31,5	106-93	11,03 - 4,53	60
3-9x40 350 Legend	A	177910	40mm	1 inch	346	31,5	106-93	11,03 - 4,53	60
3-9x40 Muzzleloader	F	174184	40mm	1 inch	346	31,5	106-93	11,03 - 4,53	60
4-12x40	C	185336	40mm	1 inch	371	31,5	106-95	7,17 - 3,33	80
4-12x40 CDS	A	180600	40mm	1 inch	371	31,5	106-95	7,17 - 3,33	80

All models are Second Focal Plane (SFP). For more information, see page 64.

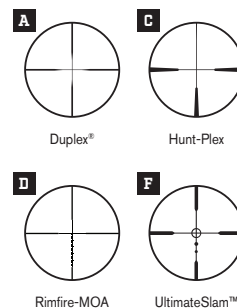

For more information and to see enlarged reticles, see pages 64-72.



FREEDOM RDS



All red dots are not created equal. The Freedom RDS® (red dot sight) changes the game when it comes to consistency and durability in a red dot sight. We took our 70+ years of optics knowledge and created a red dot that's built Leupold® tough, performs in extreme conditions, and won't break the bank. It's everything you need in a red dot and nothing you don't.

FREEDOM RDS Red Dot Sight	RETICLE Model #	Weight (g)	Length (mm)	Elev. Adj. MOA
1x with Mount	A 180092	195,6	134,62	80
1x .223 BDC with Mount	A 180093	195,6	134,62	80
1x CDS without Mount	A 186280	195,6	134,62	80



The new CDS dial option comes with a standard 1/4 MOA per click dial. Your first custom dial is FREE.

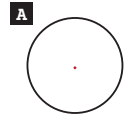

1 MOA Dot

8 brightness settings ranging from night-vision compatibility to full-daylight visibility

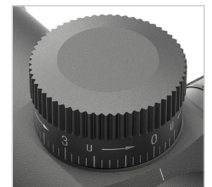

NEW

Available with CDS Elevation Dial





MARK 5HD

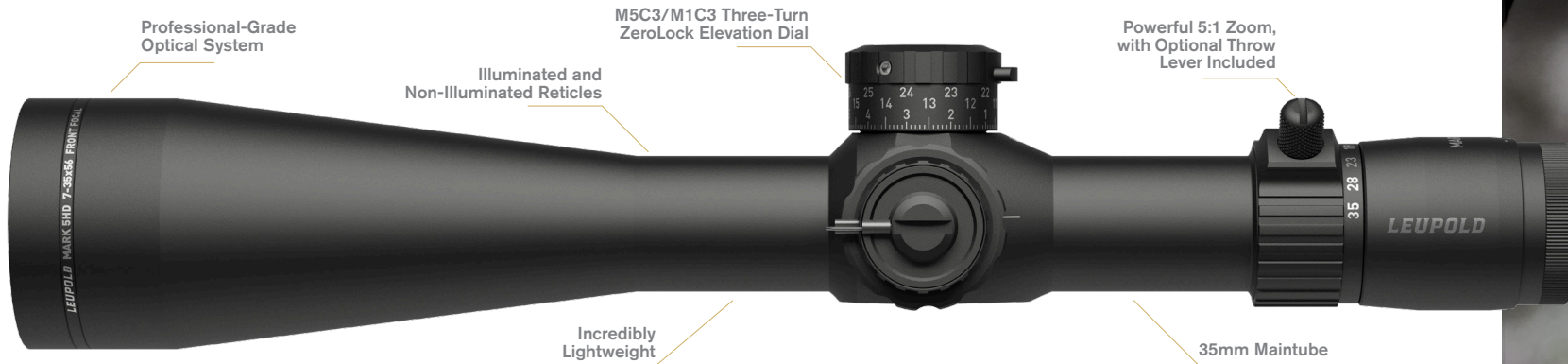
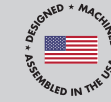

Pick up a Mark 5HD™ and you'll feel the difference: it's up to 567 grams lighter than other scopes in its class. Get behind one and you'll see the difference, from the superior edge-to-edge clarity and extreme low-light performance, to the versatility of the PR2™ reticle. With three revolutions of elevation adjustment, the Mark 5HD was built to max out the performance of the latest long-range rifles and ammo. Ergonomically designed with more tactile, audible click adjustments, larger numbers, and a high-speed throw lever so you can put accurate fire downrange faster.

Mark 5HD	RETICLE	Model #	Obj.	Maintube	Weight (grams)	Length (cm)	Eye Relief (mm)	FOV (m @ 100 m)	Elev. Adj. MOA / MIL
2-10x30 M1C3 Front Focal	F	179704	44mm	35mm	737	30,6	90 - 97	9,77 - 1,93	165 / 48
2-10x30 M5C3 Front Focal	A	179702	44mm	35mm	737	30,6	90 - 97	9,77 - 1,93	165 / 48
	M	179707							
2-10x30 M5C3 Dark Earth Front Focal	M	179709	44mm	35mm	737	30,6	90 - 97	9,77 - 1,93	165 / 48
	A	173296							
	C	173299							
3.6-18x44 M5C3 Front Focal	B	173301	44mm	35mm	737	30,6	90 - 97	9,77 - 1,93	100 / 29,1
	I	180725							
	D	176811							
	H	180726							
	J	182943							
3.6-18x44 M5C3 Dark Earth Front Focal	C	185067	44mm	35mm	737	30,6	90 - 97	9,77 - 1,93	100 / 29,1
	J	185068							
3.6-18x44 M1C3 Front Focal	F	176445	44mm	35mm	737	30,6	90 - 97	9,77 - 1,93	100 / 29,1
	G	176446							
	K	182944							
	L	176614							
3.6-18x44 M1C3 Dark Earth Front Focal	F	185066	44mm	35mm	737	30,6	90 - 97	9,77 - 1,93	100 / 29,1
	A	171772							
	C	171775							
5-25x56 M5C3 Front Focal	B	171776	56mm	35mm	850	39,8	91 - 97	6,80 - 1,40	120 / 34,9
	D	171777							
	H	180609							
	J	180222							
	H	180610							
5-25x56 M5C3 Dark Earth Front Focal	C	185072	56mm	35mm	850	39,8	91 - 97	6,80 - 1,40	120 / 34,9
	J	185071							
5-25x56 M5C3 Front Focal CW UP/R Adjustments	A	171778	56mm	35mm	850	39,8	91 - 97	6,80 - 1,40	120 / 34,9
5-25x56 M1C3 Front Focal	G	176449	56mm	35mm	850	39,8	91 - 97	6,80 - 1,40	120 / 34,9
	K	180291							
	F	176448							
	L	176616							
5-25x56 M1C3 Dark Earth Front Focal	F	185070							
7-35x56 M1C3 Front Focal	K	180292	56mm	35mm	936	39,8	91 - 97	4,90 - 1,00	100 / 29,1
	B	176124							
	D	177333							
7-35x56 M5C3 Front Focal	C	177332	56mm	35mm	936	39,8	91 - 97	4,90 - 1,00	100 / 29,1
	J	180223							
	A	176594							
7-35x56 M5C3 Dark Earth Front Focal	J	185073	56mm	35mm	936	39,8	91 - 97	5,60 - 1,10	100 / 29,1
	C	185074							
7-35x56 M1C3 Rear Focal	E	174549	56mm	35mm	936	39,8	91 - 97	5,60 - 1,10	100 / 29,1

Front Focal = First Focal Plane (FFP), Rear Focal = Second Focal Plane (SFP)

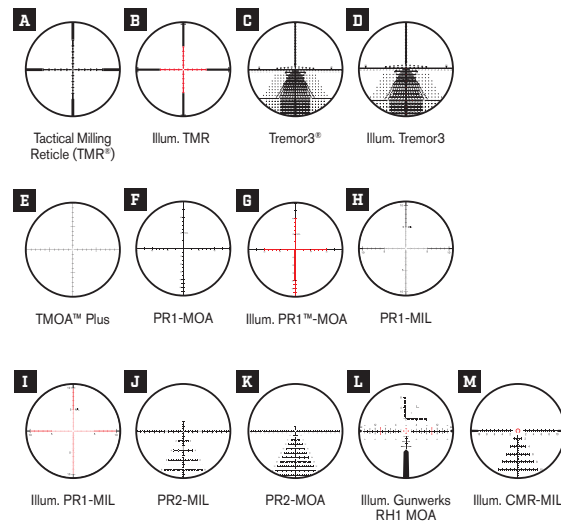

For more information and to see enlarged reticles, see pages 64-72.





MARK 4HD™

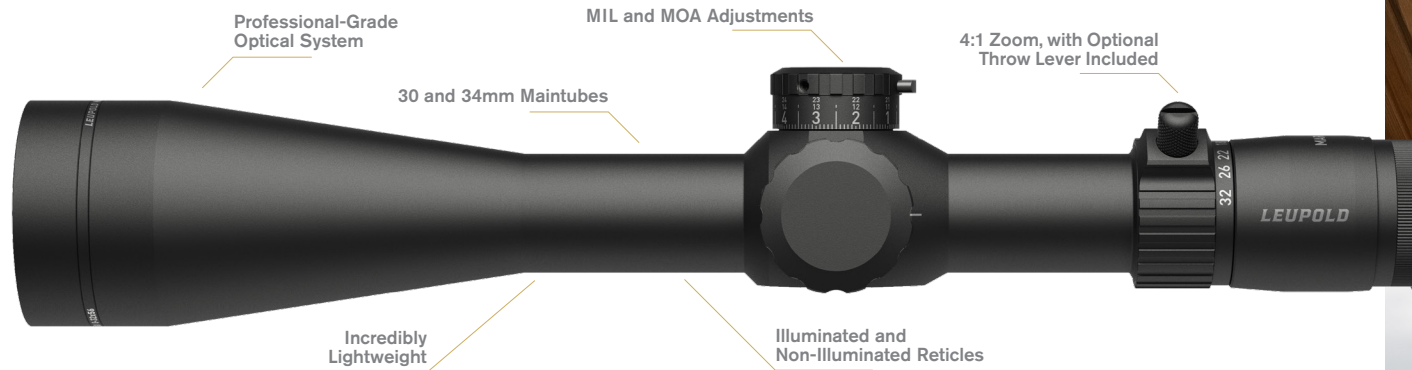

Upgrade every gun in your safe with a rugged Mark 4HD riflescope. We took the legendary performance of our Mark 5HD and gave it a slimmer maintube that's been packed full of professional-grade features. Whether you're a dedicated enthusiast or a uniformed professional, the Mark 4HD's optical clarity and lightweight design will get the job done at the range or in the field. The Mark 4HD series features five magnification ranges, giving you an accurate and reliable option for close-quarter engagements, long-range dominance, and everything in between. They're available with a three-turn elevation dial for unmatched confidence at extreme distances, a precise ZeroLock windage adjustment that won't budge when knocked around, and a side focus that'll give you tack-sharp images down to 21 meters. And like all Leupold riflescopes, they're waterproof, fogproof, and backed by our Leupold Lifetime Guarantee.

Mark 4HD	RETICLE	Model #	Obj.	Maintube	Weight (grams)	Length (cm)	Eye Relief (mm)	FOV (m @ 100 m)	Elev. Adj. MOA / MIL		
1-4.5x24 Capped E/W SFP	A	183315	24mm	30mm	510	27,1	94 - 99	39,59 - 8,40	165 / 48		
1-4.5x24 M1C3 SFP	B	183314	24mm	30mm	510	27,1	94 - 99	39,59 - 8,40	165 / 48		
1-4.5x24 M5C3 SFP	C	183316	24mm	30mm	510	27,1	94 - 99	39,59 - 8,40	165 / 48		
2.5-10x42 M5C3 SFP	D	183737	42mm	30mm	595	31,7	91 - 99	14,95 - 3,67	85 / 24,7		
2.5-10x42 M5C3 FFP	D	183738	42mm	30mm	595	31,7	91 - 99	14,05 - 3,67	85 / 24,7		
2.5-10x42 M5C3 FFP	E	183740	42mm	30mm	595	31,7	91 - 99	14,05 - 3,67	85 / 24,7		
2.5-10x42 M1C3 FFP	F	183741	42mm	30mm	609	31,7	91 - 99	14,05 - 3,67	85 / 24,7		
4.5-18x52 M5C3 Side Focus FFP	H	183624	J	183626	52mm	34mm	765	37,0	91 - 99	7,69 - 1,75	125 / 36,4
4.5-18x52 M1C3 Side Focus FFP	G	183623	I	183625	52mm	34mm	765	37,0	91 - 99	7,69 - 1,75	125 / 36,4
6-24x52 M5C3 Side Focus FFP	J	183823	K	183824	52mm	34mm	765	37,0	96 - 101	5,77 - 1,57	125 / 36,4
6-24x52 M1C3 Side Focus FFP	I	183822			52mm	34mm	765	37,0	96 - 101	5,77 - 1,57	125 / 36,4
8-32x56 M5C3 Side Focus FFP	J	183970	K	183971	56mm	34mm	850	39,6	106 - 99	4,37 - 1,22	70 / 20,4
8-32x56 M1C3 Side Focus FFP	I	183969			56mm	34mm	850	39,6	106 - 99	4,37 - 1,22	70 / 20,4

Front Focal = First Focal Plane (FFP), Rear Focal = Second Focal Plane (SFP)

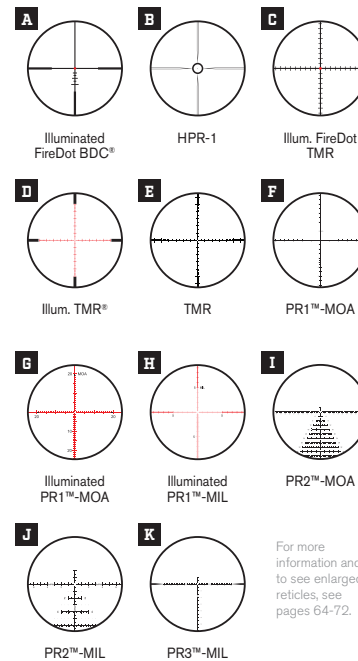

For more information and to see enlarged reticles, see pages 64-72.



NEW

PATROL 6HD™ GEN 2



With the Patrol 6HD® Gen 2, you can hit the field with confidence. Its ultra-lightweight, low-profile design and 1-6x magnification make it ideal for fast target acquisition in both tactical and competitive scenarios. Built on Leupold's Professional-Grade Optical System, it delivers exceptional light transmission, glare reduction, and the clarity you can trust in any lighting condition. The illuminated reticle draws your eye to center for quick, precise shots, while push-button controls let you adjust brightness instantly. Lightweight, rugged, and ready for action, this low-power variable optic is built for both-eyes-open speed on the range or in the field. It's waterproof, fogproof, and guaranteed to perform for life—so you can focus on the mission, not your optic.

Patrol 6HD Gen 2	RETICLE	Model #	Obj.	Maintube	Weight (grams)	Length (cm)	Eye Relief (mm)	FOV (m @ 100 m)	Elev. Adj. MOA
1-6x24 Pop Up Rezero	A	185606	24mm	30mm	445	27,1	94 - 97	36,90 - 5,90	180
1-6x24 CDS-ZL2	B	185607	24mm	30mm	453,6	27,1	94 - 97	40,30 - 6,40	180

All models are Second Focal Plane (SFP). For more information, see page 64. Gold = New Product

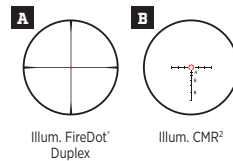

For more information and to see enlarged reticles, see pages 64-72.

Illum. FireDot® Duplex

Illum. CMR²

DELTAPOINT™ PRO

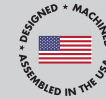

Tool-Less, Top-Loading Battery Exchange is Hassle-Free

Push-Button On/Off with Eight Intensity Settings Supports Modern White Phosphor Equipment*

Slotted 1-MOA Click Adjustments

Optional Integrated Rear Sight is a Fail-Safe Backup

Professional-Grade Red Dot Optical System

At 53.8 Grams, it's Incredibly Tough and Waterproof to 10 Meters

Motion Sensor Technology (MST) Extends Battery Life

*Night Vision Compatible Models Only



The DeltaPoint® Pro is proof that you don't have to compromise performance, even on a small sight. Whether it's topping your AR, shotgun, or pistol, the DeltaPoint Pro gives you the immense, crystal-clear field of view and bold aiming point you need in high-pressure situations. Crafted from aircraft-grade aluminum, this sight is made to handle abuse. The DP-Pro® Night Vision model has improved night vision compatibility to support modern white phosphor equipment. It features new night vision settings with micro-adjustments, and a sleek tactical finish.



Optional Integrated Rear Iron Sight



Night Vision Compatible Models



The DLOC AR Mount is the fastest, easiest, most secure way to mount a DeltaPoint Pro onto your AR. It's a tool-less, quick-mounting, detachable solution that's the ideal height for an AR platform.



DeltaPoint Pro Reflex Sight	RETICLE	Model #	Weight (grams)	Length (cm)	Eye Relief (mm)	Elev. Adj. MOA		
1x	A	119688	B	181105	53,8	4,6	Unlimited	60
1x w/AR Mount	A	177156			53,8	4,6	Unlimited	60
1x - FDE	A	175840	B	181106	53,8	4,6	Unlimited	60
1x - Night Vision	A	179585			53,8	4,6	Unlimited	60
1x Night Vision - FDE	A	179586			53,8	4,6	Unlimited	60

NV = Night Vision Compatible

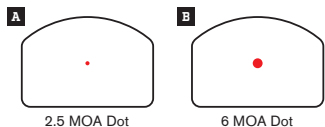

2.5 MOA Dot

6 MOA Dot





RIFLESCOPE DETAILED MEASUREMENTS

All measurements in mm except 1-inch maintubes.

Overall length may vary according to the focusing position of the eyepiece.

*Measured from the forward edge of the turret housing to the gold ring.

VX-6HD GEN 2

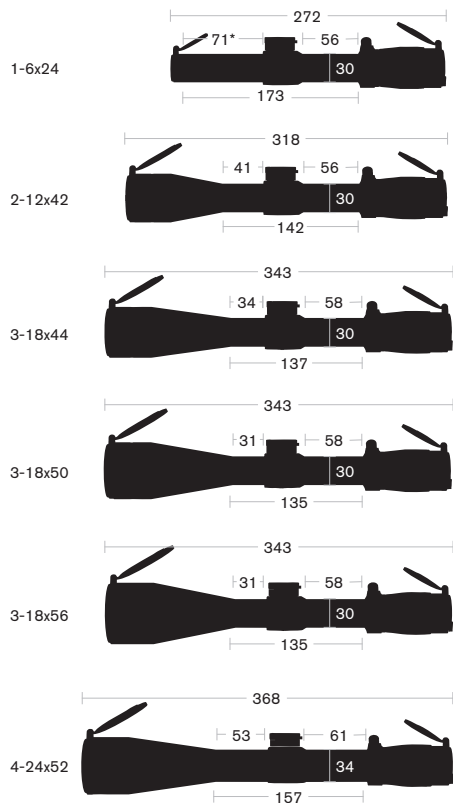

VX-5HD GEN 2

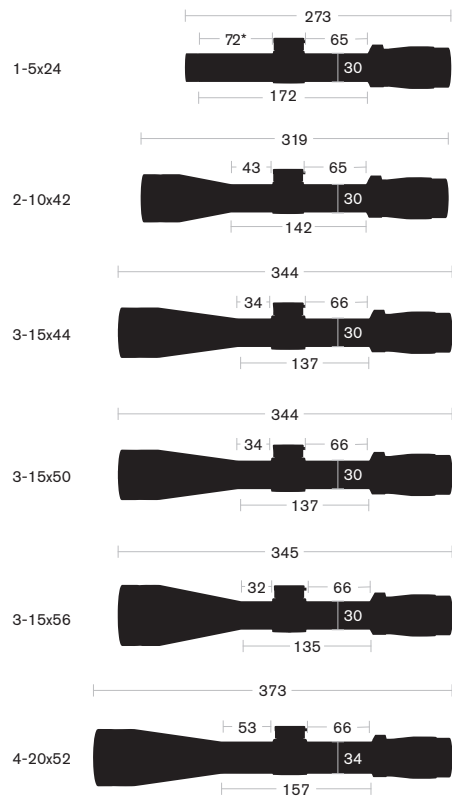

VX-4HD

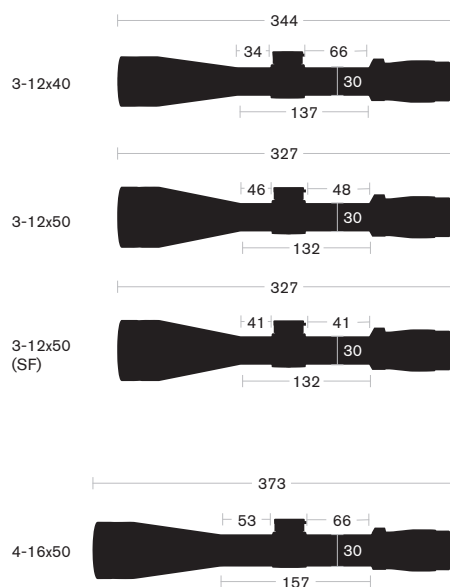

VX-3HD

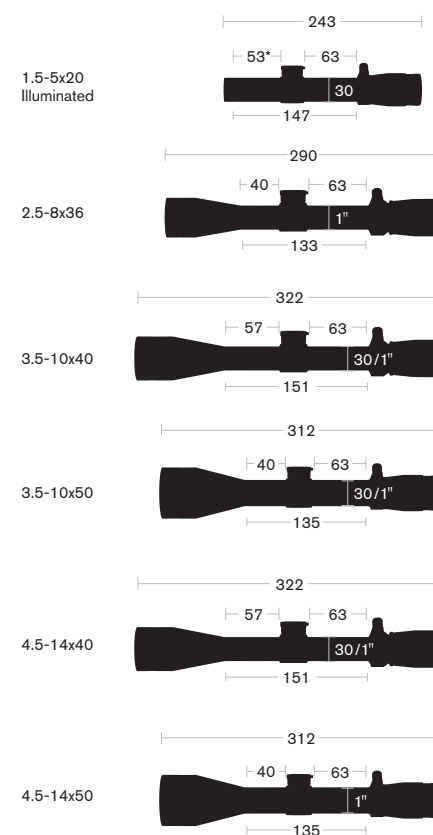

VX-FREEDOM

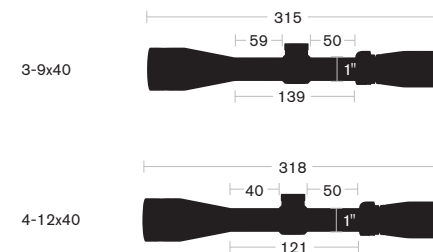

MARK 5HD

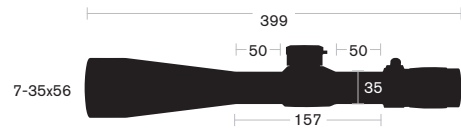
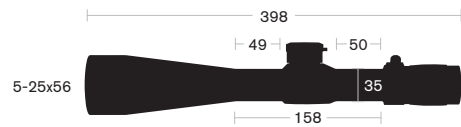
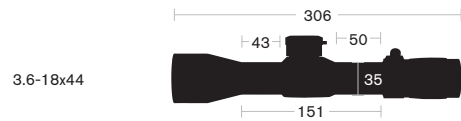
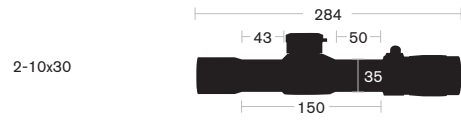

MARK 4HD



PATROL 6HD GEN 2



DELTA POINT PRO



FREEDOM RDS

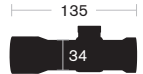





BX[®]-5 SANTIAM[®] HD



Shadow Gray

Made for picking out distant targets like Coues deer and sheep, the BX[®]-5 Santiam[®] HD binocular dominates other optics in its class. We designed the generous eyebow for long glassing sessions. The Professional-Grade Optical System ramps up light transmission and redefines low-light performance, clarity, and resolution at extreme long range.

BX-5 Santiam HD	FINISH	Model #	Actual Magnification	Obj. Aperture	Weight (grams)	Length (mm)	Eye Relief (mm)	Linear FOV (m @ 1000 m)	Angular FOV (degrees)
8x42	A	174481	8x	42mm	669	150	18,5	115	7.2
10x42	A	174483	10x	42mm	689	150	16,6	104	6.5
10x50	A	175854	10x	50mm	893	173	19,3	93	5.8
12x50	A	175856	12x	50mm	910	173	16,6	83	4.4
15x56	A	172457	15x	56mm	1276	209	18,0	70	4,4

ACCESSORIES INCLUDED

The BX-5 Santiam HD binocular comes with Leupold's GO Afield™ shoulder strap, binocular case, lens covers, and a lens cloth.



Tripod Tray included with 15x56 model

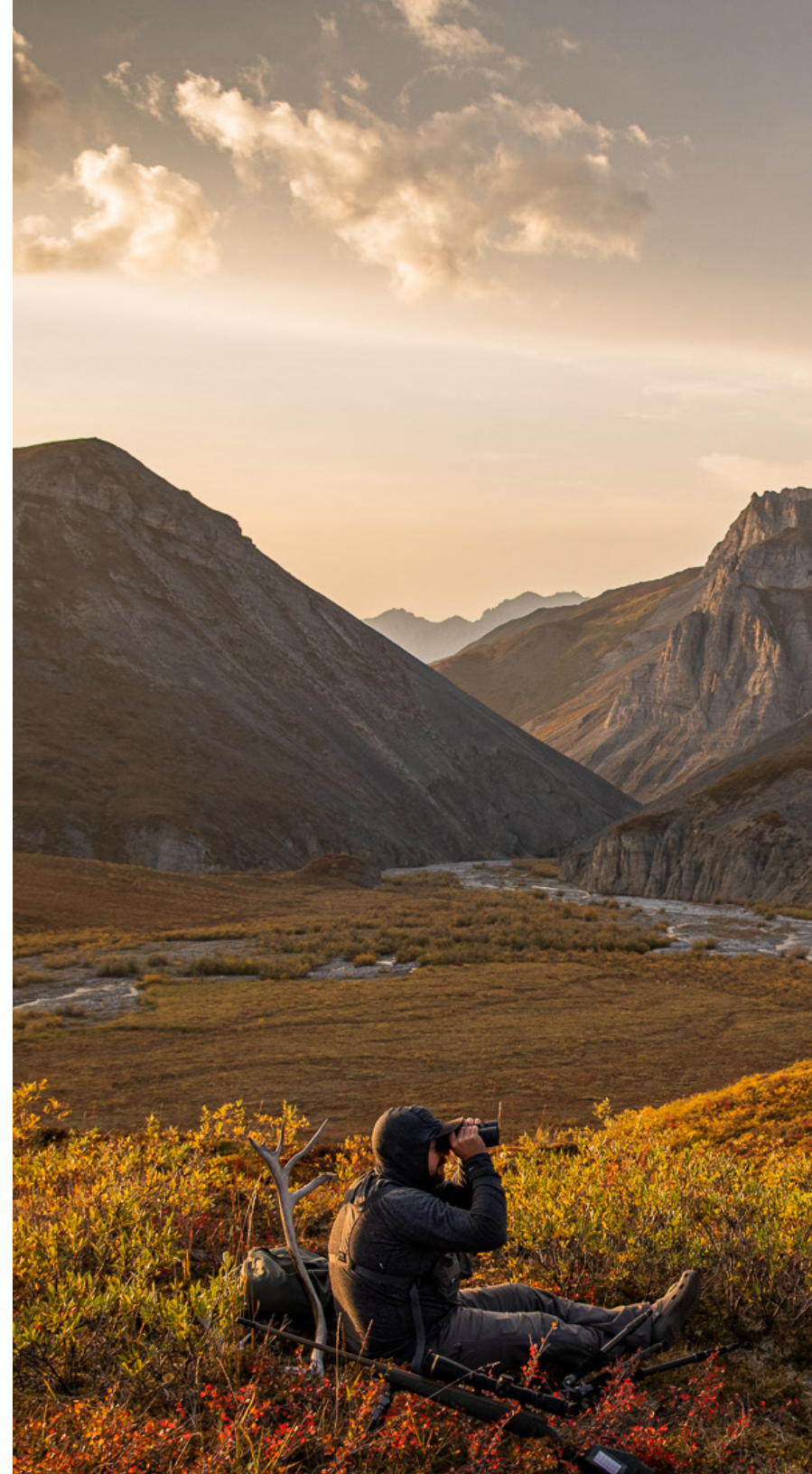

BX-4 RANGE HD TBR/W GEN 2



Shadow Gray

- Interchangeable Form-Fit Eyecups
- High Light Transmission Red OLED Display
- Right/Left Programmable Power Button
- Easy to Hold Roof Prism Design
- Elite Optical System
- Extra-low Dispersion Glass



When clarity and speed are paramount, there's no better range-finding binocular than the new BX-4 Range HD TBR/W Gen 2 featuring best-in-class light transmission, color purity and resolution. Built with the Elite Optical System, the new BX-4 Range HD delivers the same edge-to-edge clarity that our traditional binoculars provide, and its high-contrast OLED display is visible in any light. It's clear, quick and versatile, making it ideal for those who desire fast, accurate ranging up to 3,657 meters and want fewer devices to handle before getting on target. When it comes to optical performance the choice is clear, no other range-finding binocular in its class comes close.

BX-4 Range HD TBR/W Gen 2	FINISH	Model #	Actual Magnification	Maximum Range (m)			Obj. Aperture	Weight (grams)	Length (mm)	Eye Relief (mm)	Linear FOV (m @ 1000 m)	Angular FOV (degrees)
				Reflective	Trees	Deer						
10x42	A	185699	10x	3.657	1,829	1,189	42mm	1043	150	16,0	108	6,2
12x50	A	185700	12x	3.657	2,012	1,280	50mm	1049	160	14,3	91	5,2

ACCESSORIES INCLUDED

The BX-4 Range HD TBR/W Gen 2 binocular comes with binocular harness, Interchangeable Form-Fit eyecups, lens covers, and a lens cloth.



Interchangeable Form-Fit eyecups

BX-4 PRO GUIDE HD GEN 2



Shadow Gray

- Interchangeable Form-Fit eyecups
- Professional-Grade, Lightweight Performance
- Edge-to-Edge Premium HD Resolution
- Easy to Hold Roof Prism Design
- Professional-Grade Optical System
- Guard-ion Hydrophobic Lens Coating Sheds Water, Dirt, Oil, and Fingerprints



The BX-4 Pro Guide HD Gen 2 is an upgrade in both form and function. This latest version of our best-selling binocular uses high-quality glass and improved lens coatings to deliver the resolution, clarity, and glare reduction diehard hunters and shooters demand—no matter the time of day, you'll be able to conquer the challenges of harsh light and bright reflections. Along with its outstanding optical system, the BX-4 Pro Guide HD Gen 2 includes interchangeable Form-Fit eyecups that'll keep your eyes fresh through hours of hillside glassing.

BX-4 Pro Guide HD Gen 2	FINISH	Model #	Actual Magnification	Obj. Aperture	Weight (grams)	Length (mm)	Eye Relief (mm)	Linear FOV (m @ 1000 m)	Angular FOV (degrees)
8x42	A	184760	8x	42mm	663	142	19,0	123	7,0
10x42	A	184761	10x	42mm	686	142	16,0	109	6,2
10x50	A	184762	10x	50mm	793	168	18,8	94	5,7
12x50	A	184763	12x	50mm	808	168	16,0	84	4,8

ACCESSORIES INCLUDED

The BX-4 Pro Guide HD binocular comes with Leupold's GO Afield™ shoulder strap, binocular case, lens covers, and a lens cloth.



Interchangeable Form-Fit Eyecups





BX-2 ALPINE HD



Shadow Gray

Field-Replaceable Eyecups

Precision Focus Adjustments

Easy to Hold Roof Prism Design

Lightweight Magnesium Body

Elite Optical System



Whether it's your first binocular or your 50th, your glass needs to give you a bright image, feel comfortable in your hands, and be able to take a beating. The BX[®]-2 Alpine[®] HD binocular checks all of these boxes and more. It's perfect for any glass-and-go scenario. With our Elite Optical System, this bino offers excellent dawn-to-dusk light transmission for a bright image when it matters most, elite-level glare reduction in harsh light, and the resolution and clarity that diehard hunters and shooters demand. And like all Leupold[®] binoculars, it's covered by the Leupold Lifetime Guarantee.

BX-2 Alpine	FINISH	Model #	Actual Magnification	Obj. Aperture	Weight (grams)	Length (mm)	Eye Relief (mm)	Linear FOV (m @ 1000 m)	Angular FOV (degrees)
8x42	A	181176	8x	42mm	689	127	18,0	118	7,4
10x42	A	181177	10x	42mm	683	127	15,0	104	6,5
10x52	A	181178	10x	52mm	865	137	18,0	85	5,9
12x52	A	181179	12x	52mm	859	137	15,0	80	5

ACCESSORIES INCLUDED

The BX-2 Alpine HD binocular comes with Leupold's GO Afield™ Harness, lens covers, and a lens cloth.



BX-1 MCKENZIE® HD



Shadow Gray

- Field-Replaceable Eyecups
- Precision Focus Adjustments
- Easy to Hold Roof Prism Design
- Impact-Resistant Polycarbonate Housing
- Advanced Optical System



The BX-1 McKenzie® HD reveals more details than other binoculars in its class. The BX-1 McKenzie HD delivers class-leading low-light performance with our Advanced Optical System, which delivers the light transmission, glare reduction, and resolution all recreational sportsmen and sportswomen demand. Its lightweight, compact design is waterproof and purpose-built to handle the harshest conditions. And like all Leupold® binoculars, it's covered by the Leupold Lifetime Guarantee.

BX-1 McKenzie HD	FINISH	Model #	Actual Magnification	Obj. Aperture	Weight (grams)	Length (mm)	Eye Relief (mm)	Linear FOV (m @ 1000 m)	Angular FOV (degrees)
8x42	A	181172	8x	42mm	623	149	17	107	6,1
10x42	A	181173	10x	42mm	623	149	12	102	5,8
10x50	A	181174	10x	50mm	765	165	17	87	5,0
12x50	A	181175	12x	50mm	765	165	12	80	4,6

ACCESSORIES INCLUDED

The BX-1 McKenzie HD binocular come with Leupold's GO Afield™ Harness, lens covers, and a lens cloth.

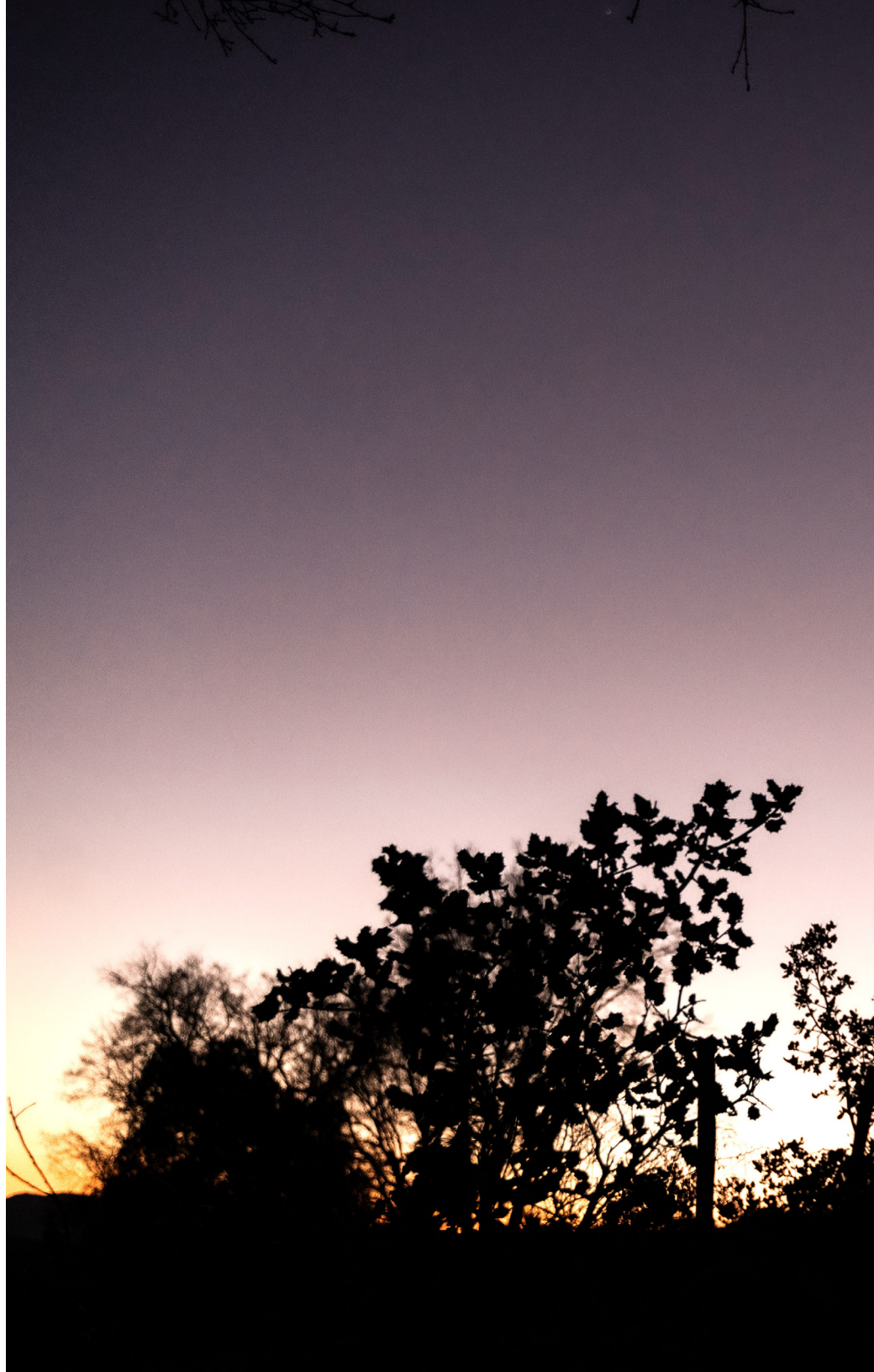

BX[®]-1 ROGUE[®]



Black

Extremely Compact,
Ideal for Day Trips or
Minimalist Hunters

Porro Prism Design
Maximizes Clarity

Fully Multi-Coated Lenses
Optimize Light Transmission



BX[®]-1 Rogue[®] compacts are at home in the field, at the game, and everywhere people want to get close to the action. The porro prism design delivers clarity and brightness that never disappoints.

BX-1 Rogue	FINISH	Model #	Actual Magnification	Obj. Aperture	Weight (grams)	Length (mm)	Eye Relief (mm)	Linear FOV (m @ 1000 m)	Angular FOV (degrees)
8x25 Compact	A	59220	8x	25mm	360	109	15,0	112	6,4
10x25 Compact	A	59225	10x	25mm	360	109	15,0	96	5,6

ACCESSORIES INCLUDED

The BX-1 Rogue Compact binocular comes with a neoprene carrying case, shoulder strap, lens covers, and a lens cloth.







SX-5 SANTIAM HD

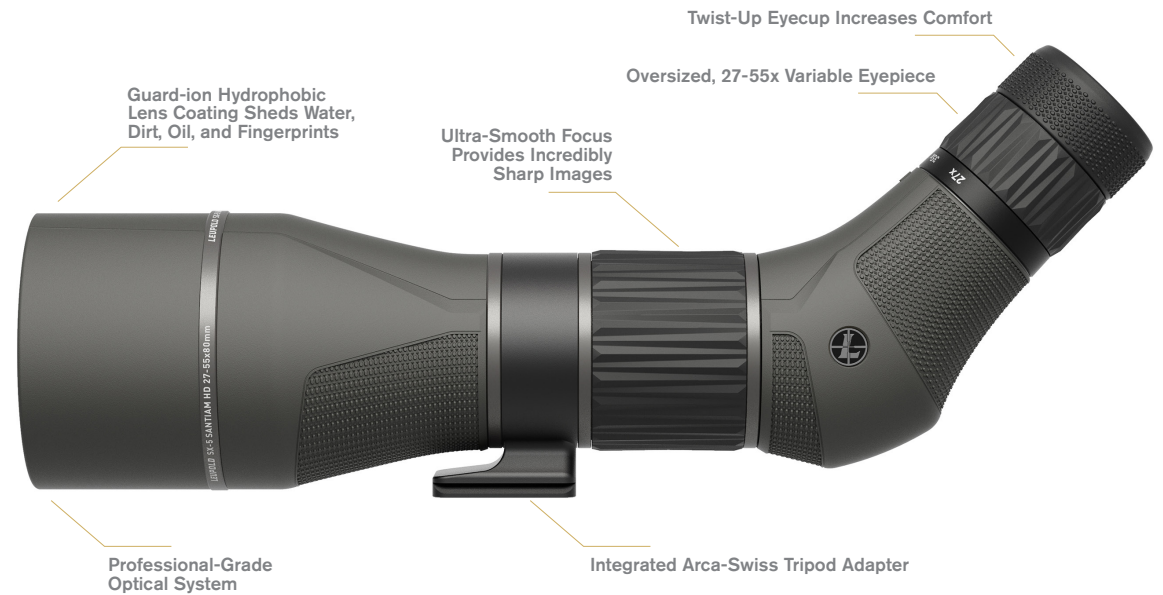

Redefining top-tier spotting scopes, the SX™-5 Santiam® HD delivers the relentless performance die-hard hunters and shooters demand. A generous eyepiece provides premium edge-to-edge clarity and unmatched sharpness and definition. With Leupold's Professional-Grade Optical System, the SX-5 Santiam HD delivers unmatched light transmission that's designed to outperform in the most challenging lighting conditions, industry-leading glare reduction for a clear image in harsh, direct light, and the resolution and clarity that professional guides and shooters demand in the field. The SX-5 Santiam HD also features a rugged, yet lightweight armor for maximum protection in the harshest conditions.

SX-5 Santiam HD	Model #	Actual Magnification	Obj. Aperture	Weight (grams)	Length (mm)	Eye Relief (mm)	Linear FOV (m @ 1000 m)	Angular FOV (degrees)
27-55x80 Straight	185605	27x - 55x	80mm	1948	381	16,6 - 19,2	32 - 22	2,0 - 1,4
27-55x80 Angled	185604	27x - 55x	80mm	1948	381	16,6 - 19,2	32 - 22	2,0 - 1,4



STRAIGHT EYEPIECE

The SX-5 Santiam HD is also available with a straight eyepiece.



SX-4 PRO GUIDE HD GEN 2

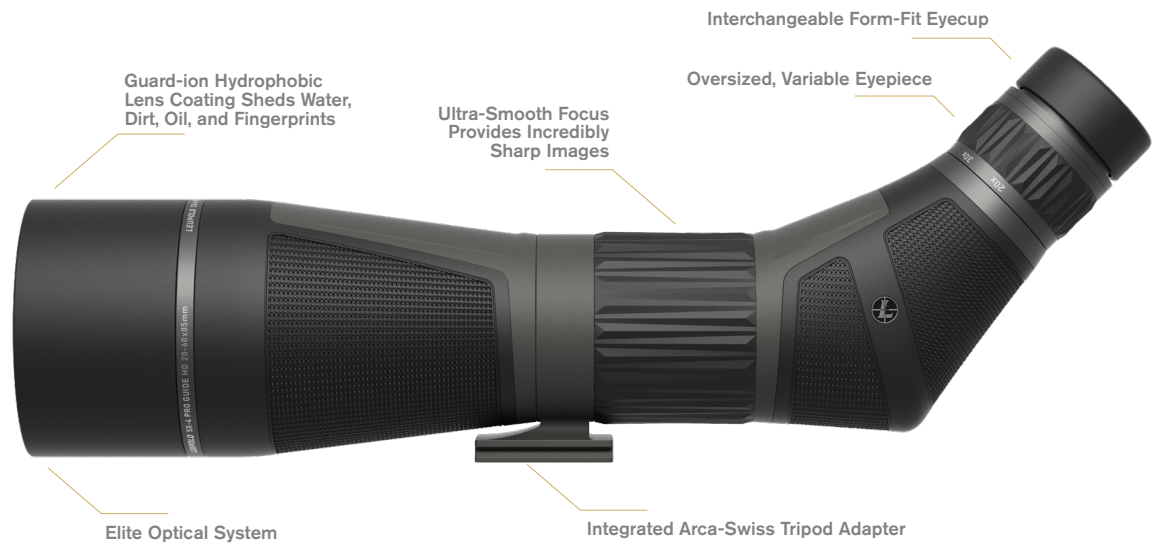

Even in extreme conditions, the SX-4 Pro Guide HD Gen 2 is an asset worth your trust. At its core is the Elite Optical System, equipped with enhanced lens coatings that significantly reduce glare, making it ideal for the bright light of early mornings. It also features an incredibly rugged magnesium body that is both waterproof and fog-proof, an oversized eyepiece for all-day comfort, and an Interchangeable Form-Fit eyecup for a personalized viewing experience. But to get the most out of it, you'll need a tripod; securely mount this optic using its built-in threads or integrated Arca-Swiss adapter.

SX-4 Pro Guide HD Gen 2	Model #	Actual Magnification	Obj. Aperture	Weight (grams)	Length (mm)	Eye Relief (mm)	Linear FOV (m @ 1000 m)	Angular FOV (degrees)
20-60x85 Angled	185679	20x - 60x	85mm	2218	452,0	19,0-17,8	30,56-16,88	1,8-1,0
20-60x85 Straight	185680	20x - 60x	85mm	2218	460,0	19,0-17,8	30,56-16,88	1,8-1,0
15-45x65 Angled	185681	15x - 45x	65mm	1760	360,0	20,0-17,6	43,6-22,7	2,5-1,3
15-45x65 Straight	185682	15x - 45x	65mm	1760	368,0	20,0-17,6	43,6-22,7	2,5-1,3



STRAIGHT EYEPIECE

The SX-4 Pro Guide HD Gen 2 is also available with a straight eyepiece.

SX-2 ALPINE HD GEN 2



Whether you're gearing up for a day at the range or embarking on your first big-game hunt, the SX-2 Alpine HD Gen 2 warrants a spot in your kit. Equipped with Leupold's Advanced Optical System, it delivers exceptional clarity throughout the day, enhanced by improved lens coatings and an Interchangeable Form-Fit eyecup. This HD performance is complemented by an integrated Arca-Swiss tripod adapter, allowing for quick and secure mounting to any Arca-Swiss-compatible head. So go on and get out there, get stable, and gain the upper hand with this next-gen optic made for detailed glassing.

SX-2 Alpine HD Gen 2	Model #	Actual Magnification	Obj. Aperture	Weight (grams)	Length (mm)	Eye Relief (mm)	Linear FOV (m @ 1000 m)	Angular FOV (degrees)
20-60x60 Angled	185683	20x - 60x	60mm	1700	365	16,7 - 19,5	35,6 - 16,9	2,04 - 0,97
20-60x80 Angled	185684	20x - 60x	80mm	1900	426	19,5 - 18,0	34 - 16	1,92 - 0,93



MARK 4 TACTICAL



The Mark 4® Tactical spotting scope gives you the brightness and clarity necessary for positive target identification in any conditions. Built to survive shocks, blows, drops, and impacts, it's not only tough, it's also waterproof and fogproof. Countless military sniper teams have trusted the Mark 4 Tactical spotting scope. You can depend on it, too.

Mark 4 Tactical	Model #		Actual Magnification	Obj. Aperture	Weight (grams)	Length (mm)	Eye Relief (mm)	Linear FOV (m @ 1000 m)	Angular FOV (degrees)
12-40x60	A 60040		12x - 40x	60mm	1049	315	30,0 - 30,0	56 - 18	3,2 - 1,0
	B 67185	D 182942							
	C 110183								
20-60x80	A 110826		20x - 60x	80mm	1752	390	30,0 - 30,0	40 - 14	2,3 - 0,8

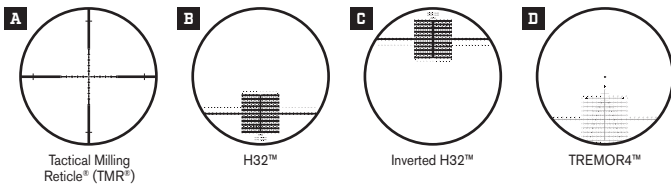

Inverted reticles allow spotting scope to be mounted upside-down on the tripod.

For more information and to see enlarged reticles, see pages 64-72.







LEUPOLD = LONG RANGE INTELLIGENCE

Accuracy, distance, and ballistics set Leupold® rangefinders above the rest. You'll get accuracy within 0.5 meters, no matter what type of target you're ranging. Best-in-class light transmission for elite optical performance makes finding your target easier than ever. Don't let a competitive rangefinder's straight-line distance or "rifleman's rule" calculations ruin your next hunt. Leupold's True Ballistic Range® (TBR®) offers a real ballistic solution. Put accuracy, distance, and TBR together and you get more than a measurement. You get long-range intelligence.

FIRST-SHOT SUCCESS STARTS WITH LEUPOLD

Hunt long enough and you're going to encounter a long-distance uphill or downhill shot. This is exactly why you need a Leupold RX rangefinder with True Ballistic Range — to take into account the angle of your shot and your rifle's ballistics to put you dead on. Line-of-Sight measurements won't put you on target. Any other rangefinder, even one with an inclinometer, won't give you an accurate range to your target, because they use basic trigonometry to calculate a straight-line horizontal distance (i.e. "rifleman's rule").

TRAJECTORY MATTERS



Read the fine print: some competitive rangefinders actually warn you not to use them at distances greater than 365 meters. We'll go so far to say it's irresponsible to shoot game at long range with anything but a RX rangefinder. Here's why.

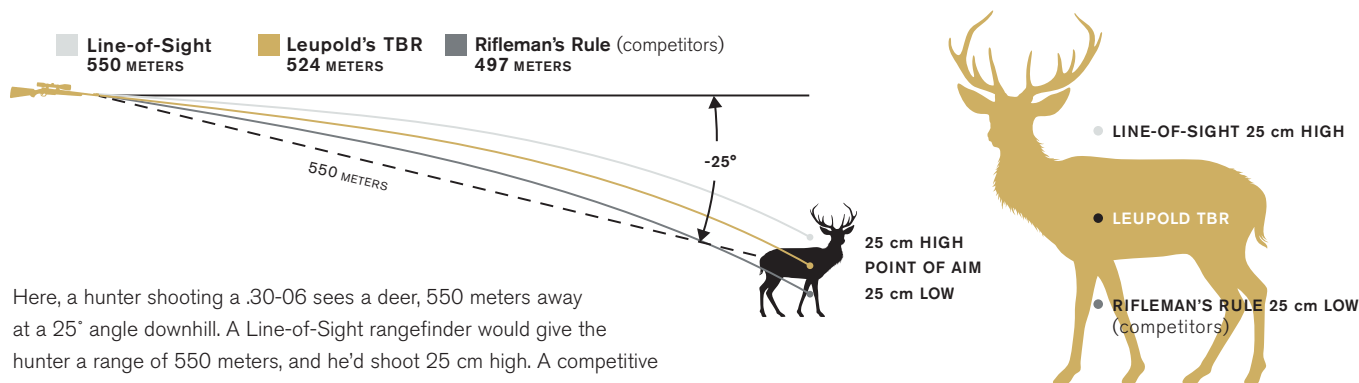

Here, a hunter shooting a .30-06 sees a deer, 550 meters away at a 25° angle downhill. A Line-of-Sight rangefinder would give the hunter a range of 550 meters, and he'd shoot 25 cm high. A competitive rangefinder with an inclinometer using "rifleman's rule" would give him a range of 497 meters, and he'd shoot 25 cm low. His RX rangefinder would give him the True Ballistic Range of 524 meters for a clean kill.

TBR/W ADDS THE WIND FACTOR

True Ballistic Range/Wind is the easiest way to account for wind out to distances of 725 meters. TBR/W generates a hold point for a 5 m/s wind at a 90° angle to your direction of aim.

ALPHA IQ® AND DNA® RANGING ENGINES

Whether you're using a rangefinder with Leupold's new Alpha IQ ranging engine or DNA engine (Digitally eNhanced Accuracy), you'll be accurate to within 0.5 meters on any target no matter its color or texture. Alpha IQ takes rangefinder intelligence to the next level. Improved pulse rate, signal-to-noise ratio, and intelligent signal processing make target acquisition lightning quick with excellent freehand ranging stability. Alpha IQ also builds upon our industry-leading target color resolution for improved accuracy on long-range readings.

ARCHER'S ADVANTAGE™ SOFTWARE

Select Leupold RX rangefinders now offer custom ballistic solutions using Archer's Advantage™ software. Using your arrow weight, arrow velocity, and peep height, Archer's Advantage™ software calculates extremely accurate ballistic solutions for high-angle short-distance shots, and medium-angle long-distance shots.

FLIGHTPATH™ TECHNOLOGY

Leupold RX rangefinders with Flightpath technology make it easy to determine if your arrow will clear obstructions between you and the target out to a typical distance of 78 meters. An illuminated mark in the display indicates the highest point of your arrow's trajectory so you can take tight shots with total confidence.

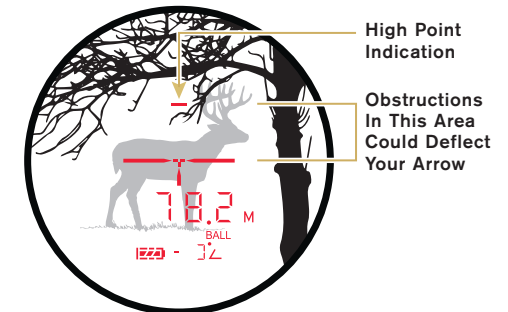

RX-5000 TBR®/W



Elevate your hunt with the RX-5000 TBR/W rangefinder. This cutting-edge device seamlessly connects to the Leupold Control App, allowing you to adjust its settings, customize display options, and take accurate ranges, all with a few quick taps on your mobile phone. But the real selling point of the RX-5000 is its pinning feature. Thanks to its GPS technology and our Long Range mode, you can now easily drop pins on a variety of digital mapping systems from over 5 km away.

(The global introduction of the App is an evolving process.)

RX-5000 TBR/W	FINISH	Model #	Actual Magnification	Reflective Range (m)	Weight (grams)	Dimensions (cm)	Eye Relief (mm)	Linear FOV (m @ 1000 m)
RX-5000 TBR/W	A	184681	8x Monocular	4.572	275	L: 10,9 / H: 7,4 / W: 3,8	16,0	112



Black

APP AVAILABLE FOR iOS & ANDROID



USE YOUR FAVORITE MAP



BX-4 RANGE HD TBR/W GEN 2



Shadow Gray

- Interchangeable Form-Fit Eyecups
- High Light Transmission Red OLED Display
- Right/Left Programmable Power Button
- Easy to Hold Roof Prism Design
- Elite Optical System
- Extra-low Dispersion Glass



When clarity and speed are paramount, there's no better range-finding binocular than the new BX-4 Range HD TBR/W Gen 2 featuring best-in-class light transmission, color purity and resolution. Built with the Elite Optical System, the new BX-4 Range HD delivers the same edge-to-edge clarity that our traditional binoculars provide, and its high-contrast OLED display is visible in any light. It's clear, quick and versatile, making it ideal for those who desire fast, accurate ranging up to 3,657 meters and want fewer devices to handle before getting on target. When it comes to optical performance the choice is clear, no other range-finding binocular in its class comes close.

BX-4 Range HD TBR/W Gen 2	FINISH	Model #	Actual Magnification	Maximum Range (m)			Obj. Aperture	Weight (grams)	Length (mm)	Eye Relief (mm)	Linear FOV (m @ 1000 m)	Angular FOV (degrees)
				Reflective	Trees	Deer						
10x42	A	185699	10x	3.657	1,829	1,189	42mm	1043	150	16,0	108	6,2
12x50	A	185700	12x	3.657	2,012	1,280	50mm	1049	160	14,3	91	5,2

ACCESSORIES INCLUDED

The BX-4 Range HD TBR/W Gen 2 binocular comes with binocular harness, Interchangeable Form-Fit eyecups, lens covers, and a lens cloth.



Interchangeable Form-Fit eyecups

RX-1400i TBR®/W GEN 2



The RX®-1400i TBR®/W Gen 2 enters the market as the most feature-rich rangefinder in its class. With our proprietary DNA® laser engine and an exceptionally bright red display, this rangefinder will give you fast, accurate, and visible readings every time. Its True Ballistic Range/Wind technology delivers custom shoot-to distances based on your rifle cartridge, and its Flightpath feature indicates possible arrow obstructions when you're hunting with a bow. All this functionality comes wrapped up in an incredibly rugged, lightweight polymer housing, making the RX-1400i TBR/W the perfect choice for your next big adventure.



RX-1400i TBR/W	FINISH	Model #	Actual Magnification	Reflective Range (m)	Weight (grams)	Dimensions (cm)	Eye Relief (mm)	Linear FOV (m @ 1000 m)
RX-1400i TBR/W with DNA	A	183727	5x Monocular	1280	170	L: 9,6 / H: 7,3 / W: 3,3	16,2	112



Gray/Black



RX-FULLDRAW 5



Your bow is custom-built to you, so your rangefinder should be, too. The RX-FullDraw® 5 combines the lightning-fast accuracy of Leupold's DNA® engine with the acclaimed Archer's Advantage™ software, making it the most ballistically advanced rangefinder on the market. Using your personal ballistics, shot distance, and angle compensation, the RX-FullDraw 5 calculates laser-accurate ranges based on your specific gear. Loaded with features designed for the modern archer, like Flightpath™ technology, we take the guesswork out of achieving the perfect shot every time.



RX-FullDraw 5 with DNA	FINISH	Model #	Actual Magnification	Reflective Range (m)	Weight (grams)	Dimensions (mm)	Eye Relief (mm)	Linear FOV (m @ 1000 m)
RX-FullDraw 5 with DNA	A	182444	6x Monocular	1100	212	L: 97 / H: 74 / W: 33	17	107



Green/Black





BECNARA

The Becnara fuses Leupold performance with everyday style. Polarized, rugged, and incredibly clear; they will never let you down. Any day or any adventure, the Becnara stands out in the field.

Rx-Ready	Polarized	Frame Fit	100% UVA Protection	100% UVB Protection
•	•	Regular-Wide	•	•



#179102
Matte Black/Gloss Black,
Shadow Gray Flash



#179101
Matte Black/Tortoise,
Bronze Mirror



#179103
Matte Black,
Bronze Mirror



#179632
Matte Tortoise,
Blue Mirror



#182677
Dark Gray,
Shadow Gray Flash



#186755
Matte Black,
Daylight Max

BRIDGER

We built the Bridger performance eyewear to keep up with competitors like you. Wherever you go, and whatever you do, its ballistic-rated, In-Fused polarized lenses will eliminate glare so you can focus on your next step.

Rx-Ready	Polarized	Frame Fit	100% UVA Protection	100% UVB Protection
•	•	Narrow-Regular	•	•



#182672
Matte Black,
Shadow Gray Flash



#182673
Matte Tortoise,
Bronze Mirror



#182674
Dark Grey,
Blue Mirror



#182675
Matte Black,
Bronze Mirror



#186747
Matte Tortoise,
Emerald Mirror



#186748
Matte Black,
Blue Mirror



#186756
Matte Black,
Daylight Max

CHEYENNE

The Cheyenne features a low-profile frame that makes it the perfect option for hunters and shooters with smaller faces. Its full wrap design offers complete protection from the elements, while maintaining maximum visibility and air flow. If you want eyewear that looks and feels great without sacrificing safety, the Cheyenne is the pair for you.

Rx-Ready	Polarized	Frame Fit	100% UVA Protection	100% UVB Protection
•	•	Narrow-Regular	•	•



#181280
Matte Black,
Shadow Gray Flash



#181281
Matte Tortoise,
Bronze Mirror



#186745
Matte Black,
Daylight Max



#186746
Matte Black,
Blue Mirror

DESOTO

The DeSoto is inspired by trailbreakers who push boundaries and redraw maps. Its shatterproof lenses with In-Fused polarization offer unbeatable protection against harsh glare and impacts, while its no-slip bridge ensures a comfortable fit. From its temple tips to its hinges, every aspect of the DeSoto can handle the rigors of prolonged expeditions.

Rx-Ready	Polarized	Frame Fit	100% UVA Protection	100% UVB Protection
•	•	Regular	•	•



#184361
Matte Black,
Shadow Gray Flash



#184363
Matte Black,
Bronze Mirror



#184364
Matte Black,
Emerald Mirror



#186738
Matte Black,
Blue Mirror



#186739
Matte Black,
Daylight Max



#186740
Matte Tortoise,
Bronze Mirror

KATMAI

The Katmai is the choice for any adventurer. Lightweight, rugged, and exceptionally clear; they can be trusted to keep your eyes fresh and your vision true.

Rx-Ready	Polarized	Frame Fit	100% UVA Protection	100% UVB Protection
•	•	Narrow-Regular	•	•



#197079
Matte Black,
Shadow Gray Flash



#197079
Dark Gray,
Shadow Gray Flash



#197079
Matte Tortoise,
Bronze Mirror

NEW

SKYLINE

The Skyline™ delivers purpose-built, polarized protection in a clean, angular frame that's right at home in the field, on the water, or behind the wheel.

Rx-Ready	Polarized	Frame Fit	100% UVA Protection	100% UVB Protection
•	•	Regular-Wide	•	•



#186751
Matte Black,
Shadow Gray Flash



#186749
Matte Black,
Blue Mirror



#186750
Matte Black,
Bronze Mirror



#186752
Matte Black,
Daylight Max



#186753
Matte Tortoise,
Emerald Mirror

SENTINEL

Your sight is worth protecting. The Sentinel performance eyewear guards your eyes with a swappable shatterproof lens. If you're a competitive shooter or defender of the peace, the Sentinel is vital to your kit.

Rx-Ready	Polarized	Frame Fit	100% UVA Protection	100% UVB Protection
	182671 only	Regular	•	•



#182669
Matte Black,
Shadow Gray Flash



#182671
Matte Tan,
Bronze Mirror



#182670
Matte Black,
Laser Safe

SWITCHBACK

Comfortable on the range, in the field, or on the ride home, the Switchback™ will quickly become a favorite addition to your everyday kit. Lightweight comfort, and unquestionable clarity gives you everything you need and nothing you don't.

Rx-Ready	Polarized	Frame Fit	100% UVA Protection	100% UVB Protection
•	•	Regular-Wide	•	•



#179092
Matte Black,
Shadow Gray Flash



#179093
Matte Black,
Emerald Mirror



#19629
Matte Grey,
Blue Mirror



#186741
Matte Black,
Blue Mirror



#186742
Matte Black,
Daylight Max



#186743
Matte Black,
Bronze Mirror

TRACER

When you're a dedicated shooter, the Tracer™ is an absolute must-have. Interchangeable lenses (included), and weather-resistant coatings are combined with Leupold's unmatched clarity and durability.

Rx-Ready	Polarized	Frame Fit	100% UVA Protection	100% UVB Protection
•	179090 only	Narrow-Regular	•	•



#179098
Matte Black,
Shadow Gray Flash



Yellow and Clear lenses included



#179090
Shadow Tan,
Bronze Mirror



Yellow and Clear lenses included



#186744
Matte Black,
Daylight Max



Yellow lenses included



#186754
Matte Black,
Blue Mirror



Yellow lenses included

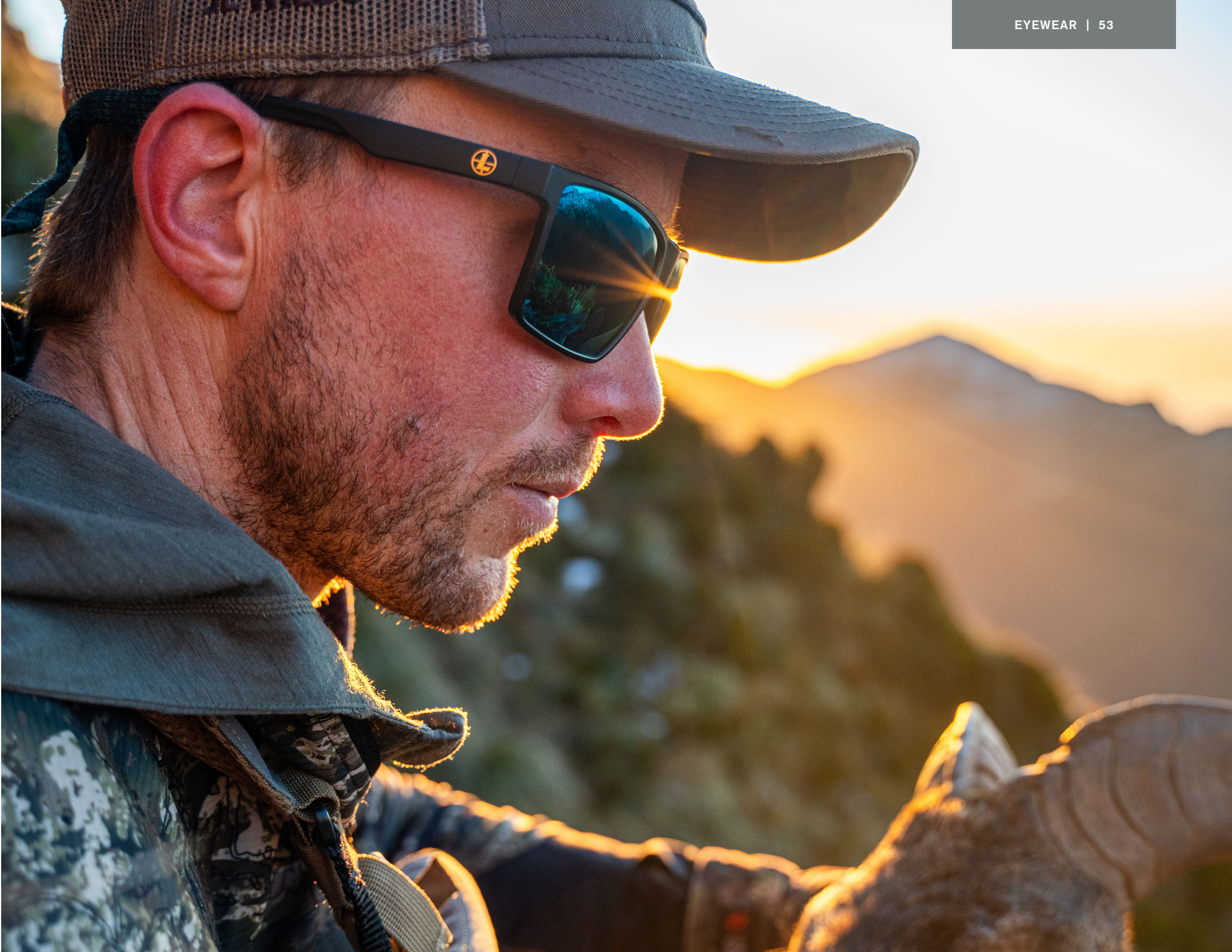





RENDEZVOUS RIFLE CASE

When you're always on the move, clutter becomes chaos. Whether you're driving to a PRS match, heading to a trailhead, or taking the long way home, this semi-structured rifle case will keep you organized km after km. #183918



RENDEZVOUS CARBINE CASE



There's no time to separate your eye pro from your ear pro when you've got places to be and records to break. That's why the Rendezvous Carbine Case is made to hold it all. From guns to gloves to glass and everything in between, your gear will arrive intact and ready for action. #183917

RENDEZVOUS PISTOL CASE



Holster wear is acceptable, even commendable. But when you store your gun for travel, it should never pick up any new scars. Protect your pistol from damage in the confines of this durable case. #183916

RENDEZVOUS BOW CASE



Crafted with rugged, weather-resistant materials, this case ensures your bow is shielded from the elements. Its thoughtfully designed compartments and padded interior offer secure storage and easy transport, making it an essential accessory for any archer on the go. #183919

OPTICS GO GEAR DUFFLE

When it's time to hit the road, the Optics GO Gear Duffle is the bag to reach for. Its weather-resistant, modular design protects and stores everything from riflescopes to your backcountry cook kit. This duffle features 360 degrees of padding, a loop-lined interior, and a set of removable hook-backed dividers to organize your gear. On the top of the bag, two tripod attachment straps will hold any Leupold tripod, so you'll always have one hand free when you're on the move. #182402



ENCLOSED BINOCULAR HARNESS



While a scratched arm isn't a big deal, a scratched optic could seriously disrupt your plans. Our fully enclosed binocular harness is a wearable solution that will prevent you from having to cut your day short due to damaged glass. Magnetic version #185628

Non-Magnetic version features an elastic closure system, designed without magnets, supporting the functionality of both traditional and electronic compasses. #185627

PRO GUIDE® RANGEFINDER POUCH

The Leupold Pro Guide Rangefinder Pouch is designed for silent operation featuring a magnetic fold-down lid and a fleece-lined interior. Its structured webbing fastens directly to the Pro Guide Bino Harness 2 and can also be attached to belts and MOLLE. #182415



Leupold.com
See the full lineup of Leupold® Pro Gear at Leupold.com.

GO AFIELD™ BINOCULAR HARNESS

This rugged, feature-rich harness will keep your binoculars and small accessories safe, secure, and accessible. Nonelastic, adjustable harness webbing keeps the pouch secure against your body. #172543



PRO GUIDE® SEMI AUTO HOLSTER

The Pro Guide Semi-Auto Holster attaches to belts, MOLLE, and the bottom of the Pro Guide Binocular Harness 2. This adjustable holster fits a wide variety of semi-auto handguns and small revolvers, so whatever firearm you conceal, you'll be able to take it with you on your next hunt or hike. #183578



PRO GUIDE® ZIPPERED ACCESSORY POUCH

Designed to add storage to the Pro Guide Binocular Harness 2, this pouch will carry the odds and ends that often get misplaced in the field. Its 1" structured webbing can also be attached to belts and MOLLE. #183555



PRO GUIDE® BEAR SPRAY POUCH

The next time you head into bear country, arm yourself with a fully loaded Pro Guide Bear Spray Pouch. With 1" structured webbing, it straps to belts, MOLLE, and the Pro Guide Binocular Harness 2, allowing you to lock it down wherever you find most convenient. #183554



PRO GEAR BAGS	Color	SKU
GO Afield™ Binocular Harness XF	Shadow Tan / Gray	172543
Pro Guide Binocular Harness 2	Shadow Tan / Gray	181882
Enclosed Binocular Harness / Magnetic	Shadow Tan / Gray	185628
Enclosed Binocular Harness / Non-Magnetic	Shadow Tan / Gray	185627
Optics GO Gear Duffle	Shadow Tan / Gray	182402
Pro Guide Zippered Accessory Pouch	Gray / Shadow Tan	183555
Pro Guide Bear Spray Pouch	Gray / Shadow Tan	183554
Pro Guide Semi Auto Holster	Gray / Shadow Tan	183578
Rendezvous Rifle Case	Shadow Gray / Shadow Tan	183918
Rendezvous Carbine Case	Shadow Gray / Shadow Tan	183917
Rendezvous Pistol Case	Shadow Gray / Shadow Tan	183916
Rendezvous Bow Case	Shadow Gray / Shadow Tan	183919

QUICK STEM BINOCULAR TRIPOD ADAPTER

Lightweight and slim design make tossing it in your pack easy even when space is at a premium. Quick-release button detaches your binoculars fast. Tough and dependable aluminum body stands up to abuse without losing tension. Arca-Swiss compatible base secures your binoculars to any Leupold tripod with no adapter plate needed. #182417



PRO GEAR PANHEAD



Tough and dependable 6061-T6 aluminum body. Arca-Swiss mounting plate provides maximum cross-platform versatility. Friction control handle eliminates jerky movements. #183550

PRO GEAR WINDOW MOUNT

Tough and dependable 6061-T6 aluminum body. Non-marring rubber pads ensure a firm grip that won't leave scratches. Large locking knob makes tightening and loosening the mount fast and easy. #183551



SHOOTING SADDLE

Leupold's Shooting Saddle is an ultra-light, tripod-mounted rifle rest that delivers the stability, speed, and versatility you need for accuracy in any position. You can mount it to any tripod plate using 1/4 20 or 3/8 16 adapter screws. #181303



MOUNTING TOOL

Includes a slotted screwdriver, two Torx® drivers, and five hex-head drivers. #52296



CARBON FIBER TRIPODS

Leupold's Carbon Fiber Tripods deliver maximum versatility and performance to hunters and shooters alike, with a rugged, lightweight design that's ready to go anywhere. The Mark 5 is built to mount to a rifle, and is perfect for competition shooters and predator hunters. The Pro Guide is meant for long periods of glassing and is sturdy enough to shoot from while maintaining a compact, lightweight design. The ultra-lightweight Alpine is designed for backcountry hunters and offers a tough, minimalist solution that's easy to carry on the go.

Mark 5 CF-455 Tripod Kit #182796

Pro Guide CF-436 Tripod Kit #180379

Alpine CF-425 Tripod Kit #180380



BINOCULAR TRIPOD TRAY

Instantly mount nearly any size binoculars to a tripod and lock them down quickly and securely with the hook-and-loop strap. The tray is tough, lightweight, and attaches to any tripod with a 1/4-20 mount. Covered by the Leupold Lifetime Guarantee. #172625



SCOPE COVER

Protect your Leupold from dirt and damage to keep it looking like new. Made from water-resistant, nylon-laminated neoprene.



MARK 5HD® COMPETITION SPEED DIAL

#182645



LENSPEN

Features a retractable brush and a self-replenishing microfiber cleaning tip. #48807



ALUMINA®

Leupold® Alumina® products feature precision-machined aluminum for lighter weight and durability. You can get Alumina flip-back lens covers, lens shades, anti-reflection devices (ARD™), rubber eyepiece guards, or a 15.2 m focus adapter.



Flip-Back Lens Covers



Anti-Reflection Devices



Lens Shades

RING WRENCH

#48762



ACCESSORIES	
BINOCULAR AND SPOTTING SCOPE ACCESSORIES	
Binocular Tripod Adapter Tray	172825
Tripod Panhead	183550
Window Mount Clamp	183551
Quick Stem	182417
Shooting Saddle	181303
CARBON FIBER TRIPODS	
Mark 5 CF-455 Tripod Kit	182796
Pro Guide CF-436 Tripod Kit	180379
Alpine CF-425 Tripod Kit	180380
SCOPE COVERS	
Small	53572
Medium	53574
Large	53576
X-Large	53578
XX-Large	53580
LEUPOLD ACCESSORIES	
Mark 5HD Competition Speed Dial	182645
LensPen	48807
Mounting Tool	52296
Ring Wrench	48762
Torx Screw Kit	52395
Dealer Parts Kit	184191

ALUMINA ACCESSORIES	Finish & Part No.
FLIP-BACK LENS COVERS	
Flip-Back Lens Cover - 56mm (VX-5HD, VX-6, VX-6HD, Mark 5HD, Mark 4HD)	119737
Flip-Back Lens Cover - 52mm (VX-5HD, VX-6, VX-6HD, Mark 4HD)	117610
Flip-Back Lens Cover - 50mm	59050
Flip-Back Lens Cover - 44mm (VX-5HD, VX-6, VX-6HD, Mark 5HD)	117608
Flip-Back Lens Cover - 42mm (VX-5HD, VX-6, VX-6HD, Mark 4HD)	117607
Flip-Back Lens Cover - 40mm	59045
Flip-Back Lens Cover - 36mm	59040
Flip-Back Lens Cover - 33mm	59035
Flip-Back Lens Cover - 28mm	58755
Flip-Back Lens Cover - 24mm	114756
Flip-Back Lens Cover - 20mm	59030
Flip-Back Lens Cover - Standard EP	59055
Flip-Back Lens Cover - Small EP	59060
Flip-Back Lens Cover - Large EP (VX-5, VX-6)	117611
Flip-Back Lens Cover Kit - 40mm & Standard EP	62990
Flip-Back Lens Cover Kit - 50mm & Standard EP	62995
LENS SHADES FOR POST-2004 SCOPES	
6,4 cm - 50mm Lens Shade	52350
6,4 cm - 40mm Lens Shade	56187
7,6 cm - 44mm Lens Shade	118769
7,6 cm - 50mm Lens Shade (Fits VX-6HD)	118770
7,6 cm - 52mm Lens Shade	118771
7,6 cm - 56mm Lens Shade	118772
ARD (Anti-Reflection Device)	
ARD (Anti-Reflection Device) - 30mm	62870
ARD (Anti-Reflection Device) - 36mm	62875
ARD (Anti-Reflection Device) - 40mm	62880
ARD (Anti-Reflection Device) - 50mm	62885
ARD (Anti-Reflection Device) - 60mm	62955

MOUNTING SYSTEMS



RELENTLESS PERFORMANCE STARTS HERE

Your mounting system is the crucial link between your firearm and your optic, and it's where accuracy and performance start. For Leupold's steel mounts, it all begins with red-hot, U.S. carbon steel blanks. Leupold® aluminum mounts are machined from aircraft-grade aluminum.

This is what it takes to ensure rock-solid repeatable accuracy, shot after shot, year after year. We meticulously machine each mount and after rigorous tolerance testing, we laser them with the Leupold logo. Like our riflescopes, our mounts are covered by the Leupold Lifetime Guarantee.

FIND THE RIGHT MOUNT IN SECONDS AT LEUPOLD.COM

Leupold offers an unrivaled selection of rings, mounts, and bases. Yet for every rifle and scope combination, there is one ideal mounting solution. The Leupold Mount Finder at Leupold.com makes finding yours this easy:

1. Select Your Rifle
2. Select Your Rifle Scope
3. Get The One Mount You Need

STANDARD

RINGS U.S. carbon steel, precision engineered to match all STD bases. Five heights available. Anti-slip grooves eliminate scope movement in the rings.

BASES Available in one-piece and two-piece bases. Two-piece steel bases fit right-hand and left-hand actions (available in front and rear reversible). Maximum accessibility to breech area. Front base locks a dovetail ring in place. Rear base with windage ring allows for gross left/right boresighting correction using the mounts. Rear ring secured by Nylok™ windage adjustment screws for perfect boresight windage.



CROSS-SLOT

We've updated the proven cross-slot design of these steel rings to be stronger and to give them more contact with the base for added stability and easier installation. Leupold cross-slot rings will fit on all picatinny and Weaver bases.

QRW2

(Quick Release-Rings Weaver Style)



PRW2

(Perma-Rings Weaver Style)



NEW BACKCOUNTRY

All BackCountry mounts are machined from 7075-T6 aircraft-grade aluminum for a lifetime of lightweight, rugged performance.

RINGMOUNTS

When ounces matter as much as performance, this is the mount you need.



CROSS-SLOT BASES

Fits both picatinny and Weaver-style rings. Available with zero elevation or 20-MOA for long-range shooting.



CROSS-SLOT RINGS

This updated cross-slot ring design has more contact with the base for even greater stability.



NEW LEUPOLD RINGMOUNTS

A premium solution for Ruger®, CZ®, Sako®, and other rifles requiring ringmounts. Our new Open Range Rimfire dovetail ringmounts are a no-tap mounting option for most .22 rimfire rifles with a 11mm, or 9.5 mm dovetail rail. Machined from solid steel or aluminum for superior tolerances and integrity.



OPEN RANGE CROSS-SLOT

The Open Range cross-slot ring design is machined from 6061 aluminum and delivers lightweight, rugged performance you can rely on.



NEW RIFLEMAN® GEN 2

These Gen 2 mounting solutions are machined from rugged and lightweight aircraft-grade aluminum. Bases fit popular rifle models. Match with your choice of cross-slot, rimfire or see-thru rings.



MARK 4® RINGS

Machined, aircraft-grade aluminum. Can be installed on any AR/MSR platform or any firearm with a picatinny-style base.



30mm, 34mm, and 35mm Aircraft-grade aluminum (7075)



35mm aluminum rings are now available in the finish FDE.



MARK AR®

The monolithic, cantilever design is strong and durable under the most intense conditions. The integral base/ring affixes securely to a picatinny rail. Preset ring spacing for easy mounting; mark one location on the rail for fast remounts and accurate return to zero. Available in 1", 30mm, 34mm, 34mm 20-MOA, and 35mm.



MARK IMS

The Leupold Integral Mounting Systems (IMS) family quickly and easily eliminates the two most common issues faced when mounting standard riflescopes to AR-style rifles; scope height and eye relief. All Leupold IMS products are tested to endure the rigors of the field and are covered by the Leupold Lifetime Guarantee.

Available in 34mm, 34mm 20-MOA, 35mm, and 35mm 20-MOA.



CANTILEVER

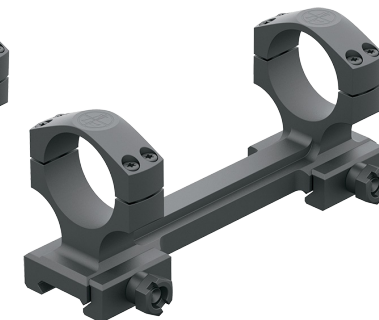

BOLT ACTION

DELTAPOINT® PRO MOUNTS



DOVETAIL MOUNTS

Provides secure installation for DeltaPoint Pro on a wide variety of handguns.



45° MOUNT

Easily attaches directly to Picatinny rails at a 45° angle. Fits DeltaPoint Pro red dot sight only. #173236



CROSS-SLOT MOUNT

For installation on picatinny rails and Weaver-style bases. #120056



DLOC MOUNT

Specifically designed for mounting the DeltaPoint Pro on AR-style firearms. #171861



RINGTOP MOUNT

Attach the DP Pro to any of our Mark 4® rings or Mark IMS mounting systems. Run it up top or at either side at a 45 degree angle.

LEUPOLD RETICLES

FOCAL PLANES DEFINED

FIRST FOCAL PLANE (FFP)

Reticle size changes in correlation to the magnification setting, allowing for accurate holdovers and range estimations at any power.

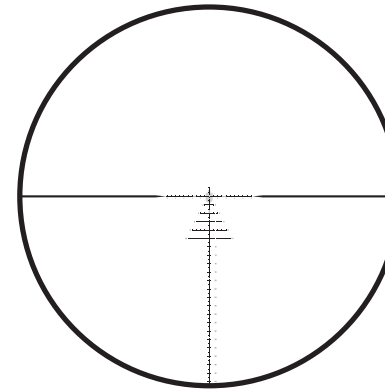

5x

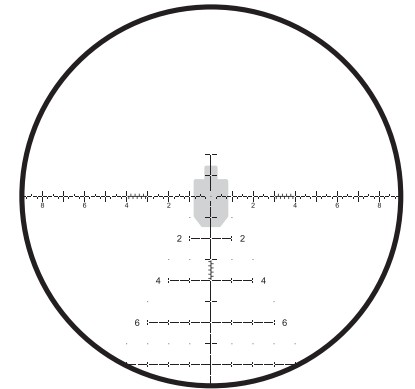

25x

SECOND FOCAL PLANE (SFP)

Reticle size remains constant regardless of the magnification setting. For accurate holdovers and range estimations, the scope must be set to the highest available power.

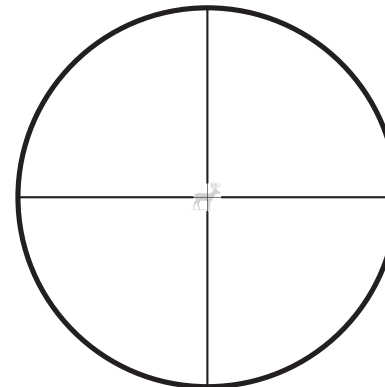

3X

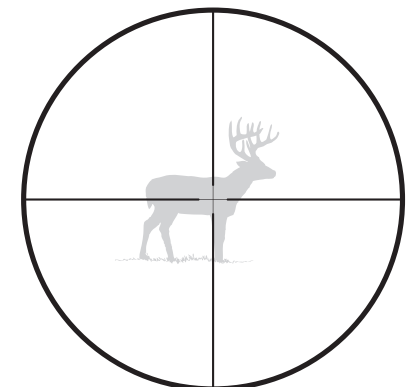

15X



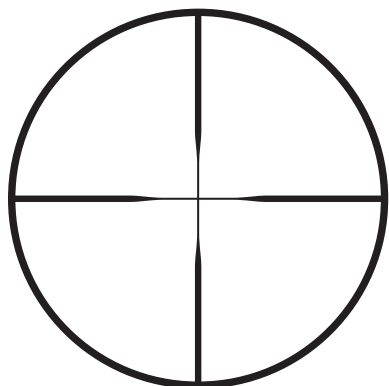

DUPLEX

Designed by Leupold in 1962, the Duplex is defined by its heavy posts — which stand out against cover and in twilight conditions — and a thin crosshair that maintains a clear view in the center.

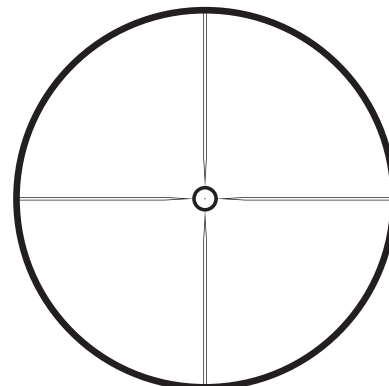

HPR-1

Specifically designed for CMP competition. Tapered posts draw the eye to center while the 0.5 MOA dot provides definitive aiming point. 8 MOA inner diameter of circle provides easy bracketing of targets.

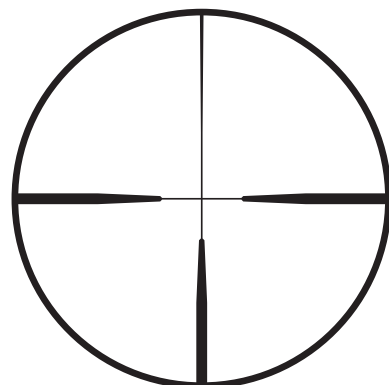

HUNT-PLEX

Designed with the hunter in mind, the Hunt-Plex reticle allows for precise shot placement in some of the toughest lighting conditions. The bold, tapered pickets draw in toward the center allowing for fast target acquisition when low-light conditions wash out the fine lines of your reticle.

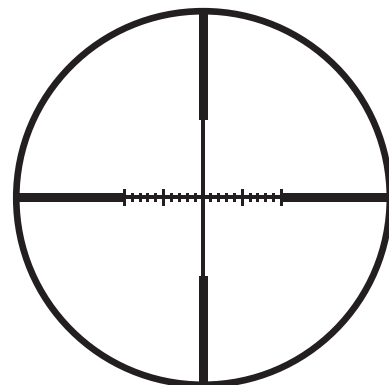

WIND-PLEX®

This reticle takes the versatility of the Duplex reticle and adds wind hold marks at 1 MOA increments on the windage plane for simple corrections. It also works with the Leupold Custom Dial System to provide a complete ballistic correction solution.

RIMFIRE-MOA

Stretch your rimfire rifle's legs out to 183 meters and more. The vertical hash marks are set for rimfire rifle ballistics at 1 MOA increments.

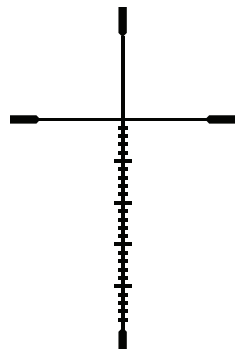
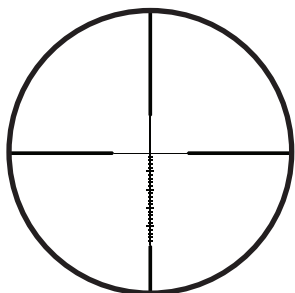

ULTIMATESLAM™

Get close in or extend your reach with hold points from 46 to 274 meters. Excellent for muzzleloaders and shotguns as well as centerfire rifles.

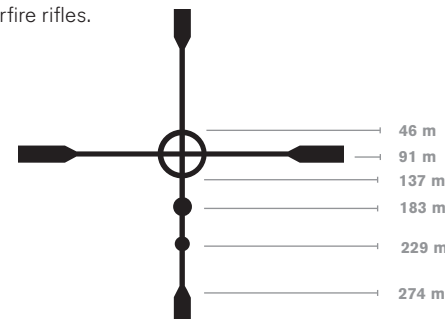
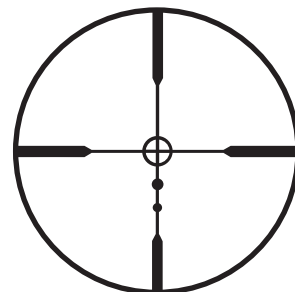

(muzzleloader drop values)

ILLUMINATED FIREDOT BOONE & CROCKETT®

This was the first optical product to bear the Boone & Crockett Club® name. You get a Duplex® aiming point with Converging Post Crosshair (CPC) style hold points and power selector ballistics tuning.

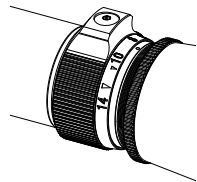
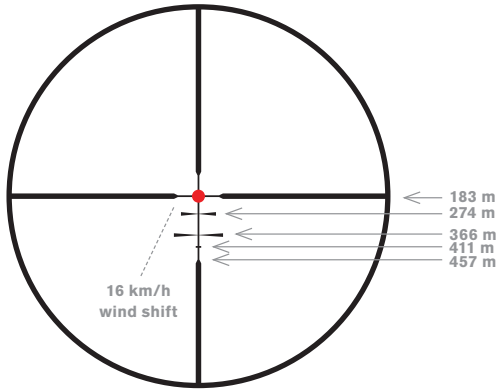

Duplex aiming point with CPC-style hold points.
Power Selector ballistics tuning.

POWER SELECTOR VALUES			
RANGE	LARGE ▼ BULLET DROP	SMALL ▼ BULLET DROP	16 KM/H DRIFT
274 m MOA	2,19	2,74	2,16
274 m mm	175	219	172
366 m MOA	4,80	6,00	3,03
366 m mm	511	638	322
411 m MOA	6,26	7,83	—
411 m mm	749	936	—
457 m MOA	7,82	9,78	—
457 m mm	1040	1300	—

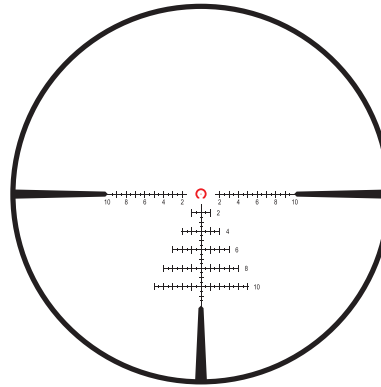

ILLUMINATED CMR-MIL

The CMR-Mil provides the flexibility needed on modern-day battlefields. It combines ranging and hold-over capability with quick target acquisition and engagement to give you the edge you need.

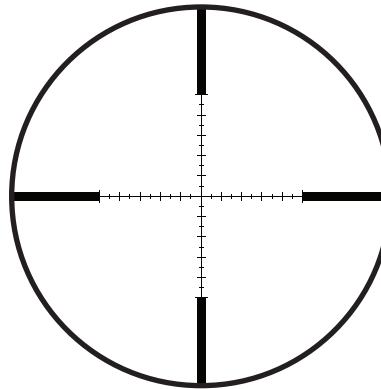

HTMR

The HTMR reticle features various sized hash marks spaced at 0.5-MIL increments along the vertical and horizontal stadia for increased ranging precision and accuracy. These measurements (subtesions) are correct when the riflescope is set to the highest available magnification. The reticle's apparent size in the field of view may vary between models of riflescope.

NEW

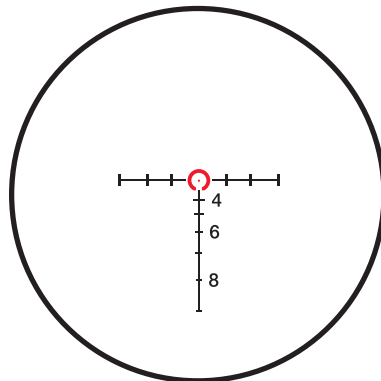

ILLUMINATED CM-R2

The CM-R2 provides the flexibility needed on modern-day battlefields. It combines the ranging ability of the Special Purpose reticle with the quick acquisition of the Circle Dot reticle to give you the edge on your target.

TMOA®

Features 1-MOA stadia lines on the horizontal and vertical crosshairs for quick bullet drop and windage correction. The crosshair is left open to create a small clear aperture for increased precision at longer ranges. TMOA can also be used to range objects of known size.

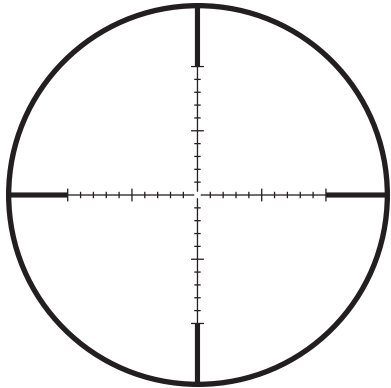

Non-Illuminated

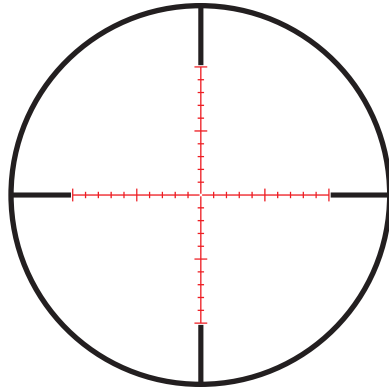

Illuminated

TMOA PLUS

Similar in design to the TMOA reticle, we added a fine plus point to the open center of the TMOA Plus for long-range aiming precision.

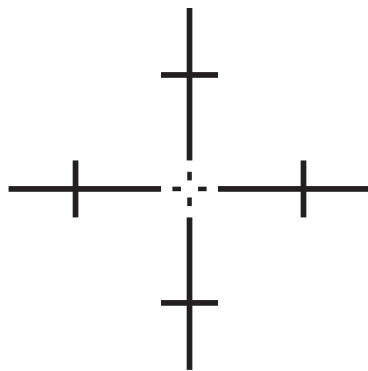
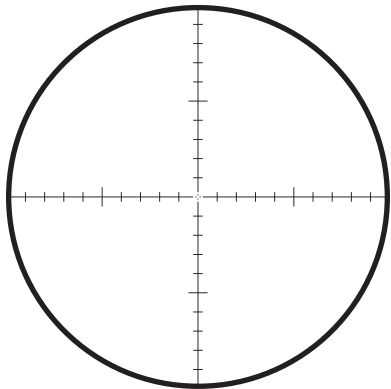

Open Center Detail



Detailed subtenon information is available in PDF format for all Leupold reticles at leupold.photoshelter.com



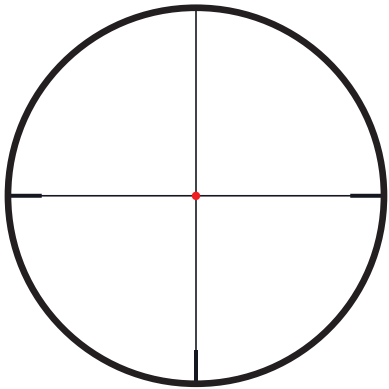

FIREDOT 4 FINE

This European-influenced design keeps the upper field free of obstructions, while the fine outer posts and fiber optic powered red dot center your target. Choose from multiple brightness settings to match the conditions. Includes Leupold's Motion Sensor Technology to conserve battery life.

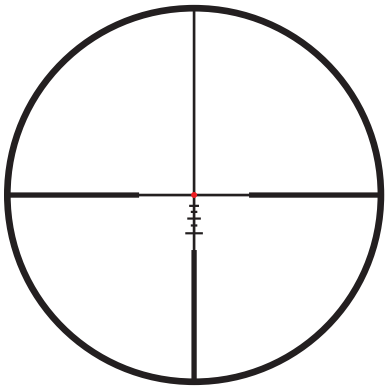

FIREDOT BDC

Designed with input from top 3-Gun shooters, the illuminated FireDot BDC reticle provides a daylight-visible illuminated center dot for rapid target acquisition in any lighting conditions. Bullet drop compensation out to 549 meters, matching most popular bullet weights for 3-Gun competition, provides accurate holdovers and compensation for 8 km/h wind drift out to 457 meters.

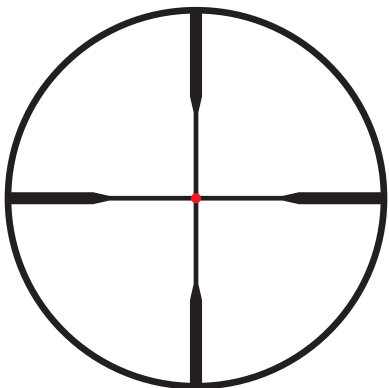

FIREDOT DUPLEX®

Takes the legendary Leupold-designed Duplex® reticle and adds an extra-bright center-point dot for quick target acquisition. Great for a broad range of game applications.

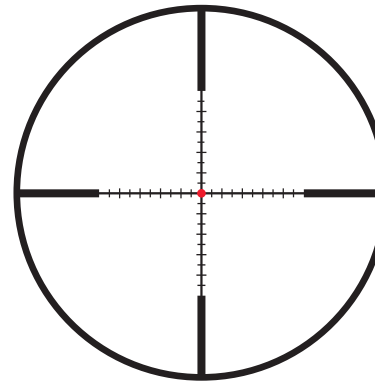

FIREDOT® TMR

(TACTICAL MILLING RETICLE)

Expanding on the traditional MIL Dot, it features various sized hash marks spaced at 0.5-MIL increments along the vertical and horizontal stadia for increased ranging precision and accuracy. The daylight-visible red illuminated FireDot® in the center of reticle aids with target acquisition and shot placement.

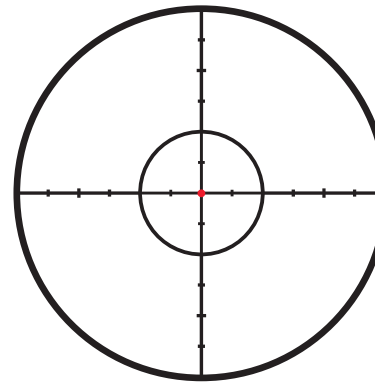

FIREDOT SPR

(SPECIAL PURPOSE RETICLE)

Provides greater precision at longer ranges than is generally possible with other reticle styles, yet it also excels in close-range, low-magnification engagements. The daylight-visible red illuminated FireDot aids in target acquisition and shot placement.

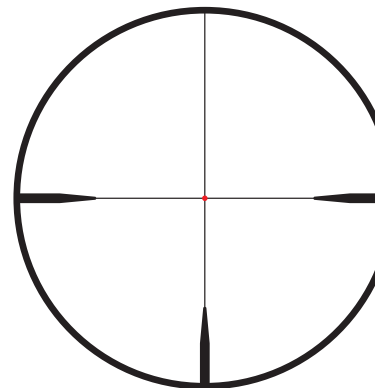

FIREDOT TWILIGHT HUNTER

Designed to help you see your aiming point even in the most challenging conditions, the illuminated FireDot Twilight Hunter reticle makes it easier to ensure your point of aim is where it's supposed to be when light is at its lowest.

PRECISION RIFLE RETICLES

Developed with input from the country's top competitors and professional shooters, the PR2™ reticles are specifically designed for long range speed and precision. Available in either MIL or MOA, the PR2 provides shooters with a clean sight picture free of clutter, allowing for fast accuracy, hold-offs, and shot correction.

PR1™ -MOA

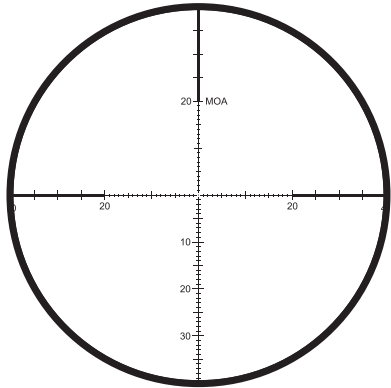

Download Detailed Substitutions
PDF

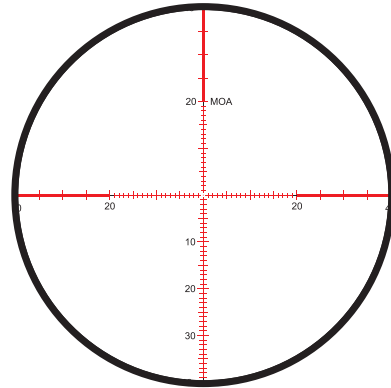

Download Detailed Substitutions
PDF

PR1-MIL

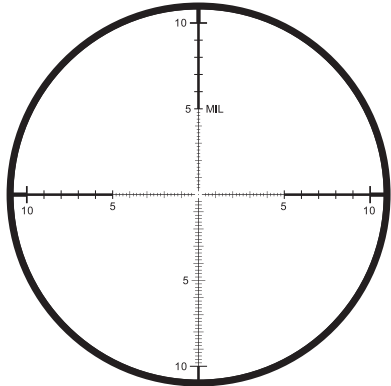

Download Detailed Substitutions
PDF

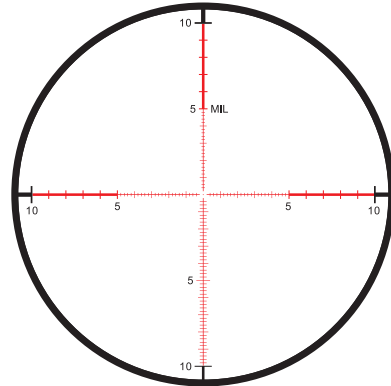

Download Detailed Substitutions
PDF

PR2™ -MOA

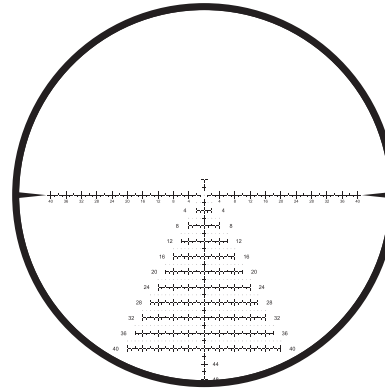

Download Detailed Substitutions
PDF

PR2-MIL

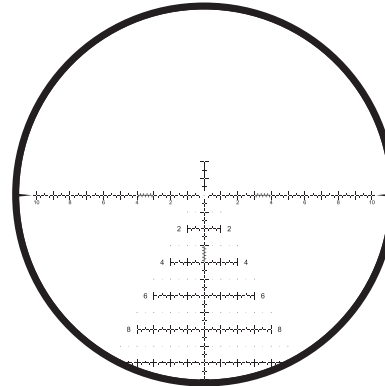

Download Detailed Substitutions
PDF

PR3-MIL

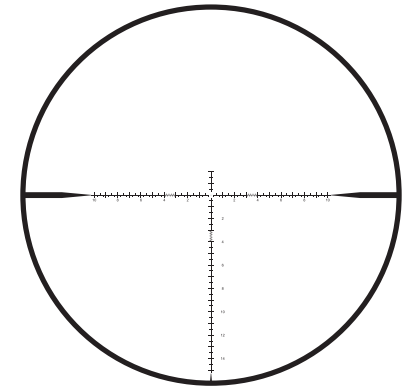

The PR3-MIL reticle is available in select Mark 4HD riflescopes



Download Detailed Substitutions
PDF

ILLUMINATED TMR

(TACTICAL MILLING RETICLE)

The Tactical Milling Reticle uses various sized and spaced hash marks on the vertical and horizontal stadia for increased ranging precision and quick one-meter range estimating reference points. To use the system, simply determine the range to the target using the MIL system, then use the corresponding aiming point that is matched to your cartridge to engage the target.

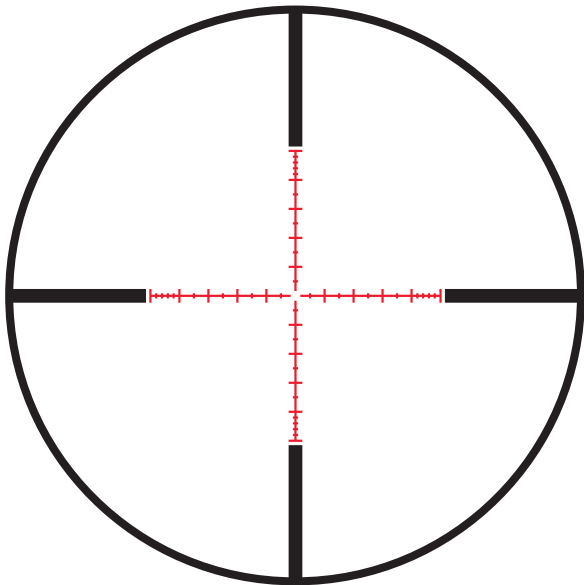

ILLUMINATED GUNWERKS RH1 MOA

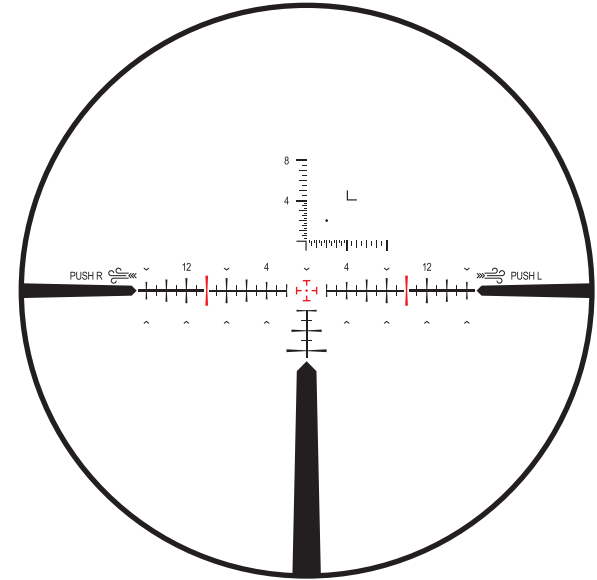

TREMOR3®



Download Detailed Subtensions PDF

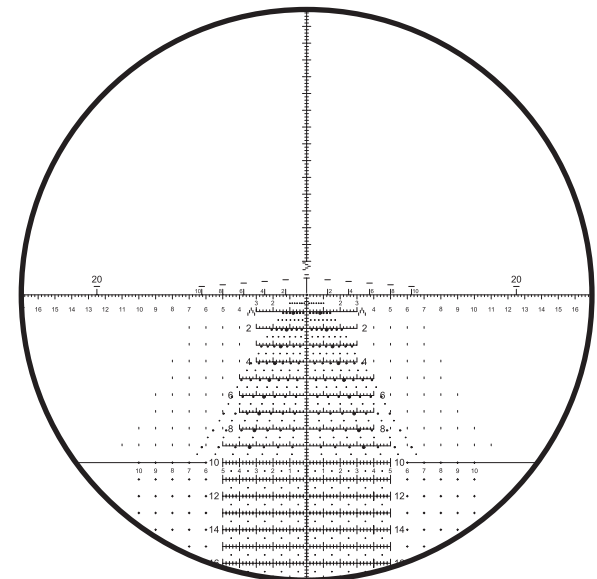

MARK 4HD

Download Detailed Subtensions PDF



MARK 5HD

Download Detailed Subtensions PDF



RETICLES BY MODEL

Choose a riflescope to see what reticles are available for that model, or choose a reticle to see what riflescopes it's available in. For the most up-to-date information, visit Leupold.com.

Reticles	VX-6HD Gen 2	VX-5HD Gen 2	VX-4HD	VX-3HD	VX-Freedom	Mark 5HD	Mark 4HD	Patrol 6HD Gen 2	DeltaPoint Pro	Freedom RDS
1 MOA Red Dot										X
2.5 MOA Red Dot									X	
6 MOA Red Dot									X	
CMR-MIL Illum.						X				
CM-R2 Illum.								X		
Duplex		X	X	X	X					
Boone & Crockett				X						
FireDot Boone & Crockett	X									
FireDot Duplex	X	X						X		
FireDot BDC							X			
FireDot SPR®										
FireDot TMR®							X			
FireDot Twilight Hunter			X	X	X					
Gunwerks RH1 MOA Illum.						X				
HTMR		X								
Hunt-Plex			X		X					

NOTE: All Firedot reticles are illuminated

Reticles	VX-6HD Gen 2	VX-5HD Gen 2	VX-4HD	VX-3HD	VX-Freedom	Mark 5HD	Mark 4HD	Patrol 6HD Gen 2	DeltaPoint Pro	Freedom RDS
PR1®-MOA Illum.						X	X			
PR1-MIL						X				
PR1-MIL Illum.						X	X			
PR2™-MIL						X	X			
PR2-MOA						X	X			
PR3-MIL							X			
Rimfire-MOA					X					
TMOA®		X								
TMOA Illum.	X									
TMOA Plus						X				
Tremor3®						X				
Tremor3® Illum.						X				
HPR-1							X			
Tactical Milling Reticle® (TMR)						X	X			
Tactical Milling Reticle (TMR) Illum.						X	X			
UltimateSlam™					X					
Wind-Plex		X	X	X						

DEFENDING WILDLIFE THROUGH CONSERVATION

The future of hunting is in all of our hands, and while we have a right to enjoy wildlife and wild places, it's our responsibility to protect it. That is why Leupold stands with and financially supports so many organizations whose mission is to conserve wildlife, as well as protect, enhance, and grow the habitat it depends on.

LEUPOLD, GOLD RING, MARK 4, the Golden Ring design, the Gold Ring box, the Circle-L reticle logo design, and various other marks are registered trademarks of Leupold & Stevens, Inc. All marks, including corporate logos and emblems, are subject to Leupold's rights and may not be used in connection with any product or service that is not Leupold's, or in any manner that disparages or discredits Leupold, or in a manner likely to cause confusion.

Certain other trademarks used in connection with Leupold products and services are the property of their respective owners and are used with permission. Torx® is a registered trademark of Acument Intellectual Properties, LLC.

For patent information, visit leupold.com/legal

Copyright © 2026 Leupold & Stevens, Inc. All rights reserved.

LEUPOLD IS HERE TO HELP

If your Leupold product fails to perform or isn't living up to your expectations in some way, we want to know, because we want to make it right. Often, by contacting one of our Product Service Specialists, you can resolve the problem without ever sending the product back to Leupold. If you do need to return your Leupold product for service, follow the steps at Leupold.com/support/service/return-warranty-services.

FOR QUESTIONS, ADVICE ON A PRODUCT, OR REPLACEMENT PARTS

Leupold's Product Service Specialists are here to answer any questions you may have about product recommendations, operation, or any other technical issues. We can even help you with spare parts. Contact us in writing to the U.S. Mail address below (Attn: Technical Service Department), by phone, fax, or email.

Phone: +1 (503) 526-1400 • **Fax:** +1 (503)352-7621 • **Email:** productspecialist@leupold.com

GET LEUPOLD'S LATEST CATALOG

You can download Leupold's latest catalog directly at Leupold.com.

FIND YOUR NEAREST LEUPOLD DEALER

Use Leupold's Dealer Locator at Leupold.com.

TO REACH LEUPOLD PRODUCT SERVICE

Parcel Service

Leupold & Stevens, Inc.
Attn: Product Service Department
14400 N.W. Greenbrier Parkway
Beaverton, OR 97006-5790 U.S.A.

Leupold Customers in Europe

For any service inquiries please contact your local Leupold dealer, where you purchased your Leupold product from.

U.S. Mail

Leupold & Stevens, Inc.
Attn: Product Service Department
PO Box 688
Beaverton, OR 97075-0688 U.S.A.
Phone: 8:00 am - 4:30 pm PST M-F
+1 (503) 526-1400

Fax: 24 hours a day, 7 days a week
+1 (503) 526-1400

E-mail: productspecialist@leupold.com

VISIT LEUPOLD.COM

Here, you'll be able to learn more about our legendary riflescopes, from how they're made to how they're tested. You'll find extensive information about all our other products, as well. Use the Leupold Scope Finder, Reticle Finder, and Mount Finder to get the perfect setup for your needs.



Find us on social media everywhere at leupoldoptics



NEUPOLD

BE RELENTLESS